



Vigilant Series

Load Center Transfer Switch



Vigilant 100A Load Center Transfer Switch

Installation and User Manual

Full Version File: VLC100 Rev1.5.doc, Aug, 2006

Thank You For Purchasing This DynaGen Product

Please Read Manual Before Installing Unit

Receipt of Shipment and Warranty Return Information

Upon receipt of shipment, carefully remove the unit from the shipping container and thoroughly examine the unit for shipping damage. In case of damage, immediately contact the carrier and request that an inspection report be filed prior to contacting DynaGen.

All returned items are to be shipped prepaid and include a Return Material Authorization (RMA) number issued by DynaGen. RMA forms are available by contacting DynaGen Technical Support through the contact methods listed below.

Limited Warranty

DynaGen will repair or replace any Vigilant Transfer Switch which proves to be defective under normal and proper use within **Three Years** from the date of shipment. This constitutes the only warranty and no other warranty shall be implied.

We welcome your comments and suggestions. Please contact us at:

DynaGen Technologies Inc.
Phone: 1-888-396-2436
(902) 562 0133
Fax: (902) 567 0633
Email: support@dynagen.ca
WEB SITE: www.dynagen.ca

Table of Contents

Vigilant Load Center Specifications	4
1.0 Vigilant Product Series	5
1.1 Receiving, Handling, and Storage	6
1.1.1 Receiving:	
1.1.2 Handling	
1.1.3 Storage	
1.2 Vigilant Product Number Identification	7
2.0 Vigilant Series Installation and Wiring	8
2.1 General Information	
2.2 Mounting Location	
2.3 Recommended Upstream Protection	
2.4 Power Connections	
2.5 Circuit Breaker Connections	
2.6 VTSC100 Controller User Connections	
2.7 Knockout Removal Procedures	
2.8 Door installation / LED alignment	
3.0 Vigilant Series General Operation	16
4.0 Vigilant Series adjustments and settings	17
4.1 System adjustment	
4.2 Timer adjustment	
4.3 Test adjustment	
5.0 Manual Transfer of Mechanism	21
6.0 Recommended Maintenance	26
7.0 Drawings	27
7.1 Vigilant Load Center General Arrangements	
7.4 Vigilant Load Center Wiring Diagrams	
8.0 Exerciser/External LED	29
9.0 Service Notes	32

Vigilant 100A Load Center Specifications

AC Current Rating	100A, 2-pole		
AC Voltage Rating	120/240V		
RSC Rating	10A Maximum		
DC Operating Voltage	12/24 VDC (Voltage Range 9 - 30 VDC)		
DC Power Consumption	25mA @ 12 VDC		
Control Setting Ranges.	Function	Range	Setting
	Time Delay Engine Start	0-32 seconds	10 seconds (1.56Vdc@ TP J2-1)
	Time Delay Transfer to Emer.	0-64 seconds	10 seconds (0.78Vdc@ TP J2-2)
	Time Delay Transfer to Norm.	0-256 seconds	256 seconds (5.00Vdc@ TP J2-3)
	Time Delay Engine Cooldown	0-256 seconds	256 seconds (5.00Vdc@ TP J2-4)
	Norm. Line Sensing Under Voltage	Dropout (11-18%) Pickup (6-13%) (+/- 2% accuracy)	Dropout (18%) Pickup (13%) (+/- 2% accuracy)
	Norm. Line Sensing Under Frequency	5-12% (+/- 1% accuracy)	12% (+/- 1% accuracy)
	Emer. Line Sensing Under Voltage	Dropout (11-18%) Pickup (6-13%) (+/- 2% accuracy)	Dropout (18%) Pickup (13%) (+/- 2% accuracy)
	Emer. Line Sensing Under Frequency	5-12% (+/- 1% accuracy)	12% (+/- 1% accuracy)
Over/Under Voltage Sensing	Dropout (11-18%) Pickup (6-13%) adjustable Percentage above or below normal voltage to recognize an unacceptable voltage condition. (+/- 2% accuracy)		
Over/Under Frequency Sensing	5-12% adjustable Percentage above or below normal freq to recognize an unacceptable frequency condition. (+/- 1% accuracy)		
Exerciser Timer	Included on 2000 series transfer switch		
Test switch	Included on 2000 series transfer switch		
UL Withstand / Closing Ratings	22,000A when used with properly rated 100A circuit breaker		
Lug Capacities	1/0 – 14 Cu 1/0 – 12 Al		
Overall Dimensions	26.00"x 14.25"x 6.00"		
Weight	45 LB		

1:0 Vigilant Load Center Product Series:

The Vigilant Load Center transfer switch series is specifically designed with all required sensing circuitry provided. The sensing circuitry allows automatic transfer of an electrical load to a stand-by power supply in the event of a drop or loss of voltage of any or all phases of the normal power supply. Upon the restoration of the normal supply, the electrical load will be automatically re-transferred to the normal power supply. Optional engine controls may be added to allow the safe operation of the generator including proper engine failure shutdown.

The Vigilant Load Center was designed with the residential home owner in mind. All standard Load Center transfer switches include both 15 and 20 amp circuit breakers. The standard switch includes five 15A single pole, three 20A single pole, and one 20A double pole circuit breakers allowing optimal connections for home circuits requiring an emergency power source. Customers have a choice to receive the load center transfer switch without breakers, allowing breakers to be purchased separately for customized arrangements.

All Vigilant Transfer switch mechanisms incorporate a double throw action switching device for automatic transferring. The Vigilant mechanism is a contactor operated device controlled by a set of normal and emergency solenoids. Manual operation is also provided for manual transfer of the power sources if necessary.



1:1 Receiving, Handling, and Storage



Receiving:

Every effort is made to ensure that your vigilant transfer switch arrives at its destination undamaged and ready for installation. The packing is designed to protect the transfer switches internal components as well as the enclosure. Care should be taken to protect the equipment from impact at all times. Do not remove the protective packaging until the equipment is at the installation site and ready to be installed.

When the transfer switch reaches its destination, the customer should inspect the shipping boxes, transfer switch and cover for any signs of damage that occurred during transportation. Any damage should be reported to a DynaGen representative once a thorough inspection is complete.

A shipping label affixed to the shipping box includes a variety of product and shipping information including product part numbers. Make certain that this information matches your order information.

Each load center transfer switch enclosure and cover is packaged in its own box. Heavy-duty cardboard sides surround the enclosure for protection. Do not discard the packing material until the transfer switch is ready for installation.

Important documents will be found inside the load center transfer switch enclosure protective packaging box including the Vigilant Load Center user manual, VTSC100 controller manual (2000 series) and system wiring diagrams are included.



Handling:

As previously mentioned, each vigilant transfer switch is packaged in its own individual box. Protect the equipment from impact at all times and do not double stack. Once the transfer switch is at the installation site and ready to be installed, the packaging material may be removed.



Storage:

Although well packaged, this equipment is not suitable for outdoor storage. If the transfer switch is to be stored indoors for any period of time, it should be stored with its protective packaging in place. Protect the transfer switch at all times from excessive moisture, dirty conditions, corrosive conditions, and other contaminants. It is strongly recommended that the package-protected equipment be stored in a climate-controlled environment of -20 to 65°C (-4 to 149°F), with a relative humidity of 80% or less. Do not stack other equipment on top of the stored switches.

1.2 Vigilant Product Number Identification



The Vigilant Transfer Switch product numbering scheme provides significant information pertaining to a specific model. The Product Number Identification Table (see Table 1) provides the required information. An example is offered to initially simplify the process.

A product number VLCX-XXXX-X-XXX-XX-X-XX-XX would consist of a combination of information from the following table.

TABLE1: IDENTIFICATION TABLE

Position 1-4	Position 6-9	Position 11	Position 13-15	Position 17-18	Position 20	Position 22-23	Position 25-26
Series	Amperage	Phase	AC Voltage	DC Voltage	Neutral Delay	Enclosure	Configuration
VTS2=2000	0100=100A	2=single	240=240V	12=12VDC 24=24VDC	X=none	N1=nema1 N3=nema3 NX=None	LS= DG Logo / Std Breakers LX= No DG Logo / Std Breakers 00= No DG Logo / No Breakers BX= DG Logo / No Breakers

Example: The Product Number VLC2-0100-2-240-12-X-N1-LS would be described as follows:

The load center transfer switch has the VTSC100 controls included. The transfer switch is designed for a single phase 120/240V system with a current rating of up to 100A maximum. The transfer switch is configured to be installed in a 12VDC system. The transfer switch does not include the Neutral Position Time Delay option (TDNP) and is shipped in a Nema 1 enclosure. The load center includes a Dynagen logo label and has the standard Dynagen breaker arrangement installed.

VIGILANT SERIES™
TRANSFER SWITCH

MADE IN CANADA

SERIAL NUMBER

RATING: VOLTS HZ

 AMPS PHASE

SYSTEM VOLTS

MODEL NUMBER

MANUF. DATE

2:0 Vigilant Series Installation and Wiring:

2:1 General Information:

All Vigilant transfer switches are factory tested and approved. Customer installation requires the mounting of the transfer switch as well as all external wiring for normal and emergency operation. Once the transfer switch is properly installed, it should be visually inspected and approved before any testing is performed. When installing the front door be certain to align the LED label on the door with the internal LED board location.



CAUTION: Adequate lifting means must be used to lift and mount the transfer switch during installation. Failure to do so could result in personal injury.

2:2 Mounting Location:

All Vigilant transfer switches require that adequate lifting means are used to install the switch at its mounting location. Be certain to choose a location that offers a flat mounting surface which is capable of supporting the transfer switch (see product specifications for proper weight details). Caution must be taken at the installation site to make sure the site is free from excessive moisture, fluctuating temperature ranges, dust, corrosive materials etc. Before any drilling takes place be certain the drilling area is free of any hazards including electrical wiring, piping etc. Extreme caution should be exercised when any installation and drilling are performed to protect the transfer switch from any debris including contaminants, filings etc. Any debris within the transfer switch may result in a system malfunction.

2:3 Recommended Upstream Protection

When protected by a circuit breaker rated at 100A maximum. This switch is suitable for use on a circuit capable of delivering not more than:

10,000A RMS SYMMETRICAL AT 240V

* For suitable circuit breakers see table 2, page 10.

Use copper or aluminum wiring 60/75C rating for power terminals.



WARNING: Power lines may carry high voltage which can cause serious injury or death. Extreme caution must be exercised when any power connections are being installed to the transfer switch. All power connections must be de-energized before any installations are performed.

2:4 Power Connections:

Proper power cables need to be installed to the transfer switch and should be installed by qualified professionals only. Improper installation or connections of these power cables are extremely dangerous and may cause severe injury or death. Utility and emergency power connections are to be connected to the proper locations on the switch contactor and neutral block. Connect the utility and emergency to the terminals which are clearly marked on the transfer switch. Three larger connection openings are located on the side of the neutral block specifically for utility and emergency neutrals (see figure 1). Verify that all connections are correct before tightening lugs. All power cable lug connections must be tightened to the proper torque values as shown in table 3.

FIGURE 1: Power Cable Connection Locations

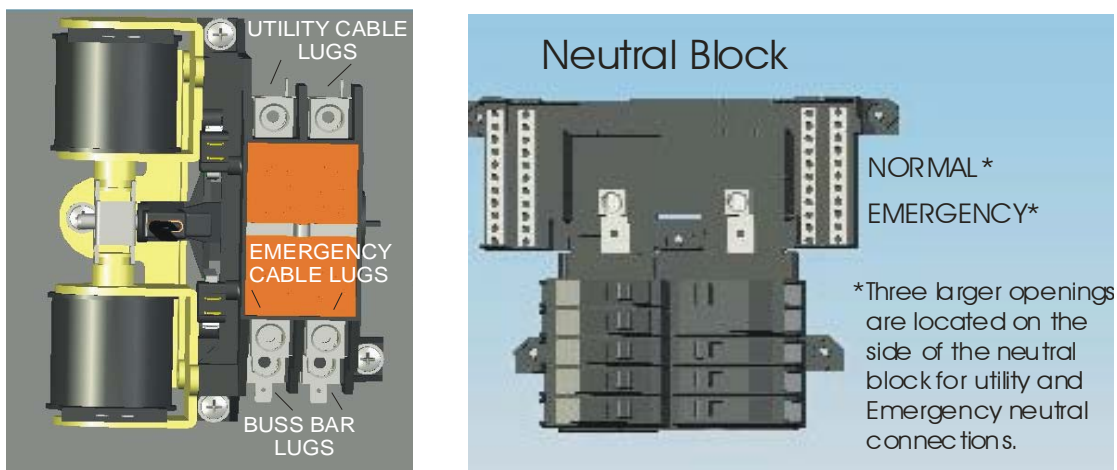

WARNING: Be certain to install the supplied transparent protective shield to the switch mechanism after the proper connections are performed. The protective shield can be found attached to the outside of the enclosed circuit breaker box. Mounting screws are supplied on the switch mechanism for easy attachment.

TABLE 2: 100A Suitable Circuit Breakers

Cat. No.	Manufacturer	Electrical Ratings
HED4	SIEMENS	125 A, 240 V, 100 KA
QCHW	CH	125 A, 240 V, 22 KA
FCL	CH	100 A, 240 V, 200 KA
FB	CH	100 A, 240 V, 200 KA
FDC	CH	150 A, 240 V, 200 KA
FI	Square D	100 A, 240 V, 200 KA
ED4, ED6	Siemens	125 A, 240 V, 65 KA
HED4, HED6	Siemens	125 A, 240 V, 100 KA
CED6	Siemens	125 A, 240 V, 200 KA

The following chart shows the required electrical tightening torque for specific power cable wire sizes.

TABLE 3: 100A Lug Torque Values

AWG or circular mill size	Tighten torque in inch pounds	
	Screw driver	External drive wrench
14	35	75
12	35	75
10	35	75
8	40	75
6	45	110
4	45	110
2	50	150
1	50	150
1/0	50	180

Wire size range 1/0 to 14 copper using Illsco lug # CA5-SP

2:5 Load Circuit Breaker Connections:

The transfer switch should be installed by qualified professionals only. Improper installation or connections of these circuits are extremely dangerous and may result in fire or severe injury. The essential load circuits are to be connected to the properly rated breakers which are included within the standard load center transfer switch assembly. Breakers need be manually installed in switches ordered with no breaker installation. When installing breakers, installation should begin from the bottom breaker locations. The standard load center transfer switch includes five 15A single pole, three 20A single pole and one 20A double pole circuit breakers allowing optimal connections for essential home circuits requiring an emergency power source. Some essential circuits would be for lights, refrigerator, furnace blower, freezer, sump pump etc. See Vigilant 100A load center wiring diagram. Please note circuit breaker ratings and locations may differ from the standard breaker configuration depending upon customer requirements or installation. Caution must be taken to read circuit breaker ratings directly from the transfer switch.

FIGURE 2: Standard Circuit Breaker Ratings/Locations



***Install breakers from bottom positions to top
The top right and left positions are left empty**

NOTE: When installing circuit breakers, install starting at the lowest position on the circuit breaker interior as seen in figure 2 above.

2:6 VTSC100 Controller User Connections:

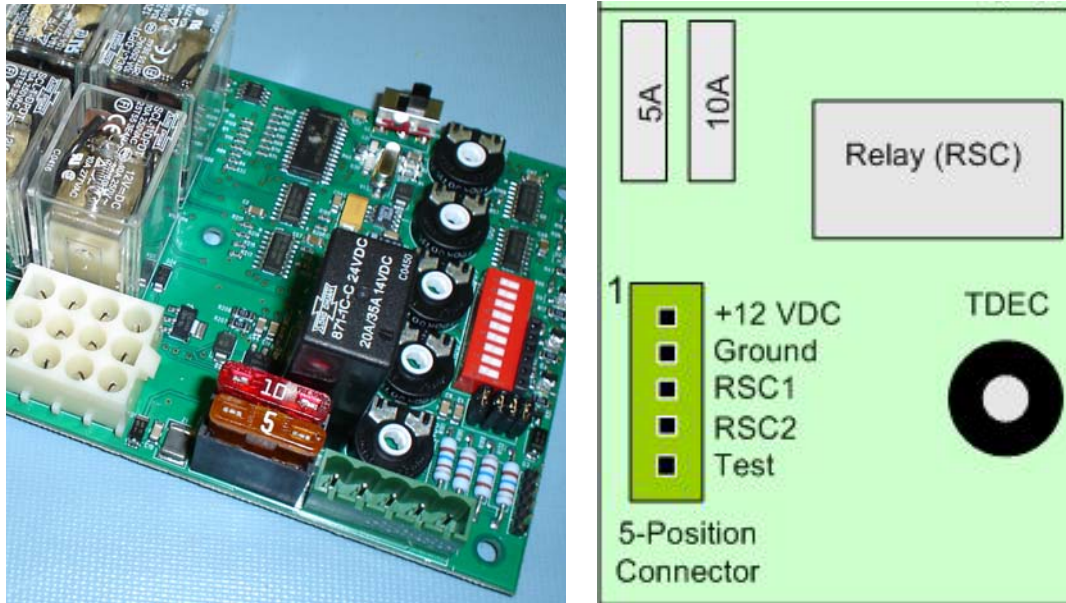

The VTSC100 has a 5-position terminal block to allow customer connections. +12VDC must be connected for operation of the VTSC100 controller. RSC1 and RSC2 need to be connected to the remote start/stop of the generator to allow automatic starting. An optional test switch may be installed by the customer using the test connection. See Vigilant load center wiring diagram.

Function	Description	Terminal	Minimum Wire Size
Power	To power and operate the VTSC100 controller	Location #1 (+12 VDC) Location #2 (Ground)	16 AWG
Remote Start	Normally open dry contacts allowing automatic start and stop of the generator	Location #3 (RSC1) Location #4 (RSC2)	16 AWG
Remote Test	Connecting Test to ground allows testing and generator exercising	Location #5 (Test)	18 AWG

2:7 knockout Removal Procedures

The circuit breaker knockout positions located on the door mechanism may need removal depending upon the product version. Standard load centers shipped with included breakers will have the knockout removal performed at the factory. Load centers ordered without breakers will require the knockout removal procedure be preformed. Knockout removals are dependant upon the breaker configuration. Knockout locations should only be removed in locations were breakers will be placed.

The knockout removal procedure is performed as follows:

1. Determine what knockouts will need to be removed.
2. Work from the front side of the door mechanism. Using a broad bladed flat screwdriver, bend the bottom knockout 31 and/or 32 sufficiently to permit the jaws of a pair of pliers to be inserted. The action of bending the knockout is shown below.
3. Work from the back side of the door mechanism. Using a pair of pliers, tightly grip the knockout with the plier's jaws. Simultaneously bend and twist the knockout to the right, and it will break free. Repeat this procedure to remove the required knockouts.

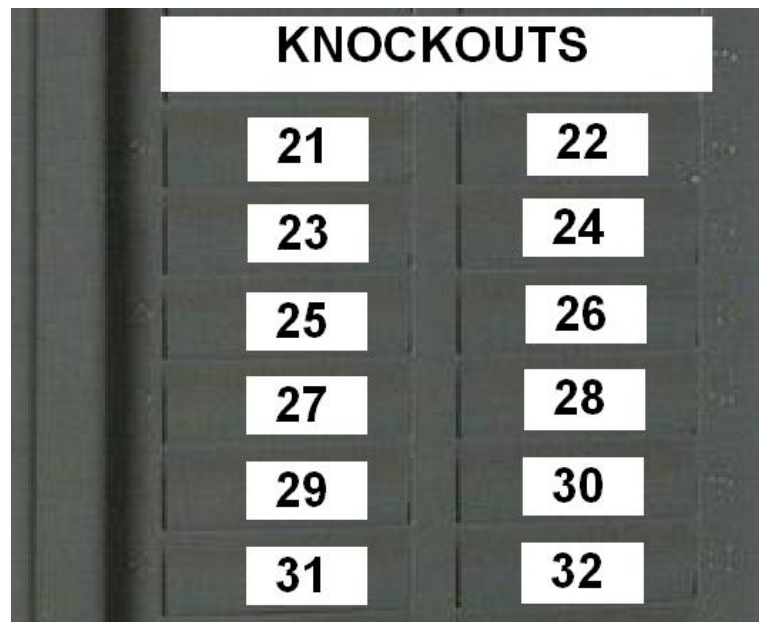

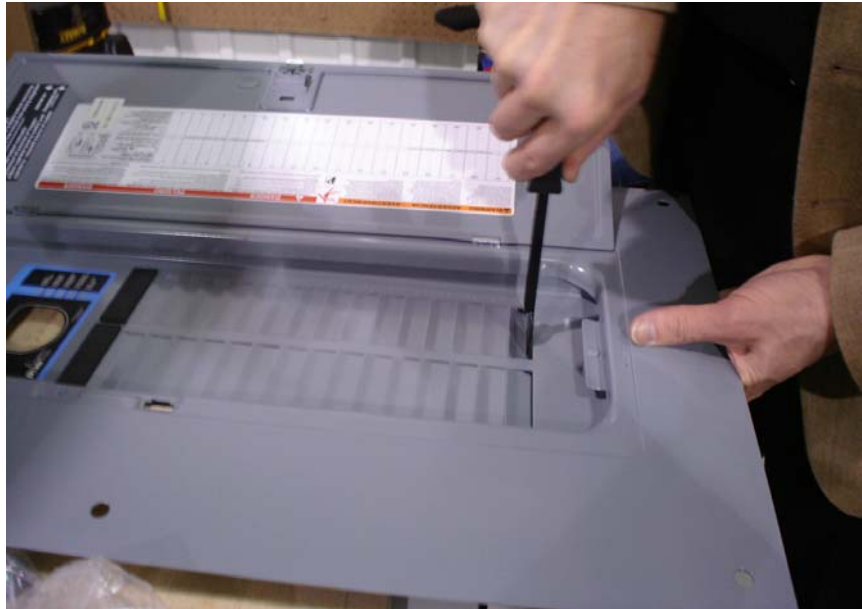

Screw driver used to bend knockout from front of door mechanism.



Pliers used to remove knockout from back of door mechanism

2:8 Door installation / LED alignment:

This procedure is intended for the installer of the load center transfer switch, and concerns the front cover attachment. Normally the front cover attachment will be the final procedure of the transfer switch installation, so that power can be made available to the unit via a separate main disconnect switch.

1. Attach the front cover assembly to the unit using the six thread forming screws. Open the door and ensure that the circuit breakers fit properly in the knockout section. Do not tighten the cover screws at this time.
2. Apply power to the unit. The “normal Available” and “transferred to normal” indicators should be illuminated.
3. Use these indicators as an aid to carefully line up the front label, by gently moving the front cover in relation to the enclosure as required. Tighten the cover screws to retain it in this position.

Note. The front cover has previously been attached to the enclosure at the factory, and the front label accurately positioned with respect to the indicator lights. This ensures that by following the above procedure, an accurate alignment of the label and the lighted indicators is assured.



Correct LED alignment



Incorrect LED alignment

3:0 Vigilant Load center Series General Operation:

The Vigilant Load Center series transfer switch in combination with DynaGen's VTSC100 timing module will allow for the automatic transfer of an electrical load to a stand-by power supply in the event of an over/under voltage or frequency condition on any or all phases of the normal power supply.

In the event of an over/under voltage or frequency condition of utility power, the onboard VTSC100 sensing circuitry will begin the initiation of the transfer process. Upon initial sensing of a loss of utility power the Vigilant series transfer switch is specifically designed to allow an engine start time delay period (TDES) to expire before starting the generator. This engine start time delay is user adjustable from the VTSC100 preventing unnecessary engine starts from a temporary loss of utility. In the event the utility source is not restored to acceptable values after the engine start time delay has expired the remote start contacts will close sending a signal to the generator's automatic start controller.

When the VTSC100 senses that the generator has started, and within acceptable limits, the transfer switch will wait until the normal to emergency time delay (TDNE) has expired before switching to the emergency position. This delay allows the generator to stabilize before any load is transferred. All connected loads are then transferred to the emergency power source.

While the transfer switch is in the emergency position, the VTSC100 will be constantly monitoring the utility source voltage and frequency status. Once the utility source is restored to acceptable limits, the Transfer switch will wait until the emergency to normal time delay (TDEN) has expired before switching to the normal position. This emergency to normal time delay is user adjustable from the VTSC100 preventing unnecessary transferring from a temporary restore of the utility source. If the utility source remains stable after the emergency to normal time delay expires the transfer switch will transfer to the normal position. All connected loads are transferred to the normal power source.

When connected loads are transferred back to the normal power source an engine cooldown period (TDEC) will be initiated allowing the generator to run in a no load condition. This engine cooldown time delay is user adjustable from the VTSC100 allowing the generator to continue running for a specific period after the normal utility is restored.

4.0 Vigilant Series adjustments and settings:



Danger: Never adjust settings while energized.
Completely isolate all sources of power from controller and transfer switch mechanism before making any adjustments.

The Vigilant Load Center Series adjustments and settings may be made from the onboard VTSC100 transfer switch controller. The general settings and adjustments for the Vigilant Load Center are as follows. Please refer to the VTSC100 controller user manual for detailed information on adjustments.

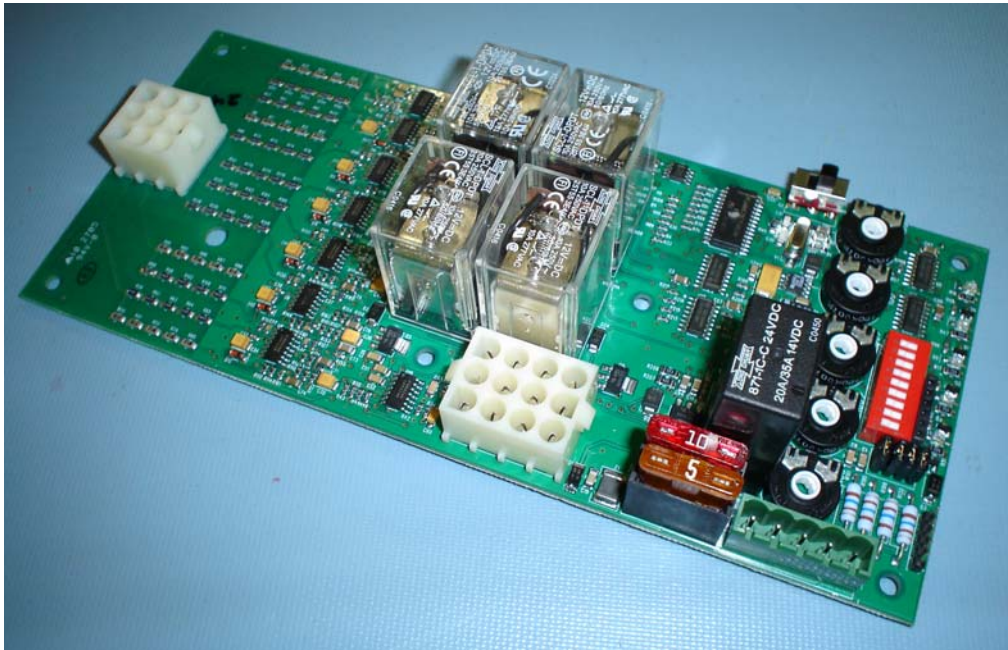

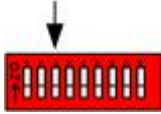

4.1 System Adjustments:

1: 120/240 or 277/480 VAC: Switch #1.

The dip switch located on the VTSC100 may be used to set the unit for 120/240 or 277/480 VAC systems. When switch location #1 is off, the system is configured for a 120/240 VAC system. When switch location #1 is on, the unit is configured for a 277/480 VAC system. Setting is factory set and must not be adjusted.

2: 50/60 HZ: Switch #2.

The dip switch located on the VTSC100 may be used to set the unit for 50 or 60 Hz systems. When switch location #2 is on, the system is configured for 60 Hz. When switch location #2 is off, the unit is configured for 50 Hz systems.

3: Load/No Load: Switch #3.

The dip switch located on the VTSC100 may be used for load/no load exerciser testing. When switch location #3 is on, the system is configured for a load test condition allowing transfer to an emergency power source. When switch location #3 is off, the unit is configured for a no load test condition with no transfer to an emergency power source. This setting applies to the engine exerciser test only. Please refer to the VTSC100 user manual for a more advanced and detailed outlook.

4: Under/Over voltage: Switch #4, 5, 6.

The dip switch located on the VTSC100 may be used to set the Over/Under voltage setting. Depending upon the positions of Dip Switch locations 4, 5 and 6 the VTSC100 will determine the percentage range to recognise a utility failure. The failure percentage adjustments can range from 11 to 18 percent of the normal power source for dropout and 6 to 13 percent for pickup. Switch 4, 5, and 6 off for 18% and on for 11% dropout. Please refer to the VTSC100 user manual for a more advanced and detailed outlook.

5: Under/Over Frequency: Switch #7, 8, 9

The dip switch located on the VTSC100 is used to set the Over/Under frequency setting. Depending upon the positions of Dip Switch locations 7, 8 and 9 the VTSC100 will determine the percentage range to recognise a utility failure. The failure percentage adjustments can range from 5 to 12 percent of the normal power source. Switch 7, 8, and 9 off for 12% and on for 5% range. Please refer to the VTSC100 user manual for a more advanced and detailed outlook.

4.2 Timing Adjustments:

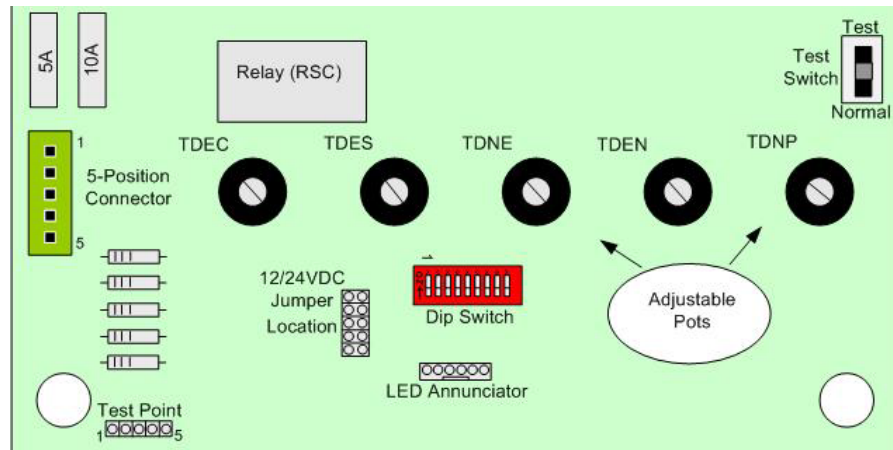

- 1: **TDES:** Time Delay Engine Start: This delay prevents unnecessary engine starts. When the TSC100 determines a utility failure it will wait for the engine start time delay to expire before trying to start the generator. The factory default setting for time delay engine start will be 10 seconds.
- 2: **TDNE:** Time Delay Normal to Emergency: This delay allows the generator to stabilize before any load is transferred. This normal to emergency time delay allows the generator to be fully running before supplying power to a load. The factory default setting for time delay normal to emergency will be 10 seconds
- 3: **TDEN:** Time Delay Emergency to Normal: This delay allows the utility source to be monitored for stability. This emergency to normal time delay allows the utility to be monitored for the set amount of time to confirm that it is fully restored and stable. The factory default setting for time delay emergency to normal will be 256 seconds
- 4: **TDEC:** Time Delay Engine Cool: This delay allows the engine to continue running after the transfer switch returns to the normal position. When the TSC100 recognizes that the transfer switch is in the normal position after a emergency to normal transfer, the generator will continue to run under a no load condition until the engine cool time delay has expired. The factory default setting for time delay engine cool will be 256 seconds
- 5: **TDNP:** Time Delay Neutral Position: This delay allows the transfer switch to temporarily stop between normal to emergency and emergency to normal transfers. The temporary stop allows controlled isolation between the both normal and emergency sources. The factory default setting for time delay neutral position will be 10 seconds. (Available if equipped)

4.3 Testing Adjustments:



1: Controller test switch:

Manual testing of DynaGen’s VLC 2000 series transfer switches may be achieved by manual adjustment of the test switch located on the VTSC100. The controller test switch will allow manual testing of the transfer switch. The purpose of the test switch is to simulate a utility power failure. Normally the test switch would be set to the normal position, allowing proper sensing for normal utility faults. To simulate a utility fault when no fault actually exists, the test switch would be set to the test position allowing the transfer switch to transfer to the emergency position. After testing, utility power can be restored simply by setting the test switch back to the normal position.



2: Exerciser:

The purpose of the exerciser is to perform a test of the transfer switch either manually or automatically. The exerciser may be customer adjusted to any specific time or day in which to perform a test. The exerciser can perform a test for a load or no load condition. For details instructions on operational and setting instructions see the “Exerciser” section on page 25.

3: Remote test switch:

The remote test switch will allow remote testing of the transfer switch. The purpose of the remote test is to perform a manual test of the transfer switch. The remote test switch may be installed by the customer; the switch would be installed between the test input on the controller and battery ground. Normally the test switch would be set to the Disable position (open), allowing proper sensing for normal utility faults. To perform a test of the transfer switch the test switch would be set to the Enable position (closed) allowing the transfer switch to transfer to the emergency position. A SPST test switch rated at a minimum of 1A should be used.

5:0 MANUAL TRANSFER OF MECHANISM



WARNING: Manual transferring is not recommended. If performing an emergency manual transfer, be certain to isolate the transfer switch from all possible load sources. Never transfer under load.

Manual transferring is not recommended. If the transfer switch fails to transfer in an emergency, an optional manually transfer may be performed. Caution must be taken to confirm that the transfer switch is isolated from all possible load sources before transferring. Always remove the handle from the manual transfer handle lever location after each transfer.

- In 100A Load Center Transfer Switches, the manual transfer lever located on the contactor is used to manually transfer between the normal (utility) and emergency (generator) position. With the lever facing up toward the normal side, the switch will be in the normal position. With the lever down facing toward the emergency side, the switch will be in the emergency position.

Removable handle for manual transfer



The removable handle can be found located attached to the protective shield located on the contactor.

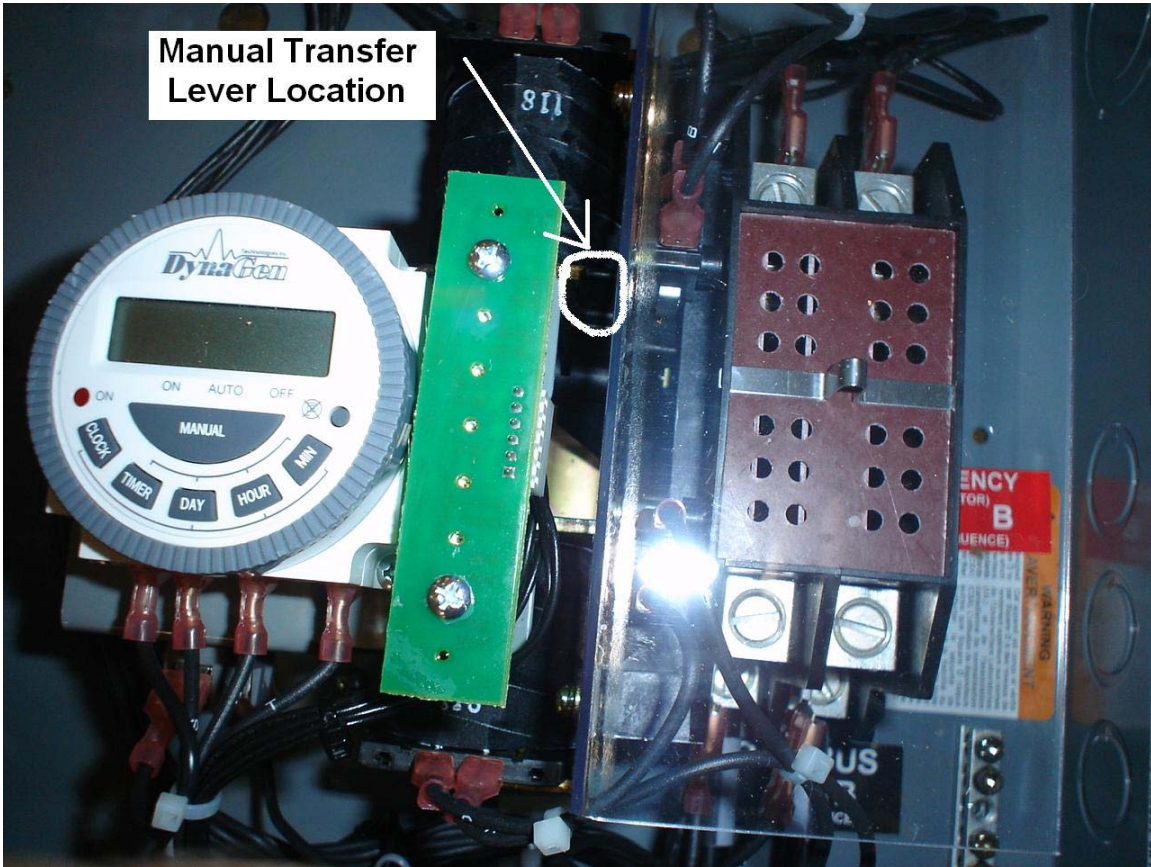

Manual Transfer
Lever Location

Manual transfer handle lever location

To perform a manual transfer the removable handle must be placed on the manual transfer lever location as follows:

1. With the removable handle placed in the position shown in the photo below, lower the handle down below the protective shield barrier to the manual transfer lever location.

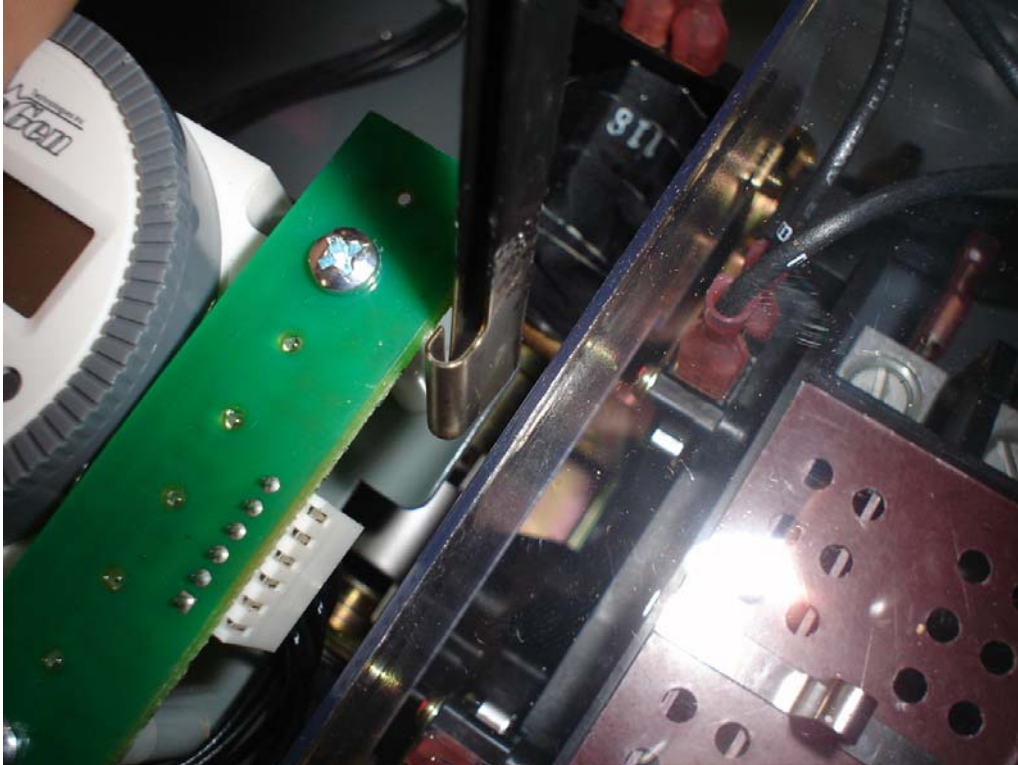

2. Turn the removal handle counter clockwise to the position shown in the photo below.

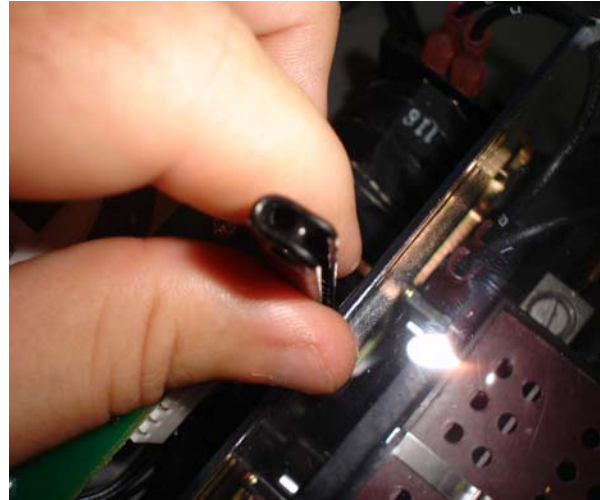
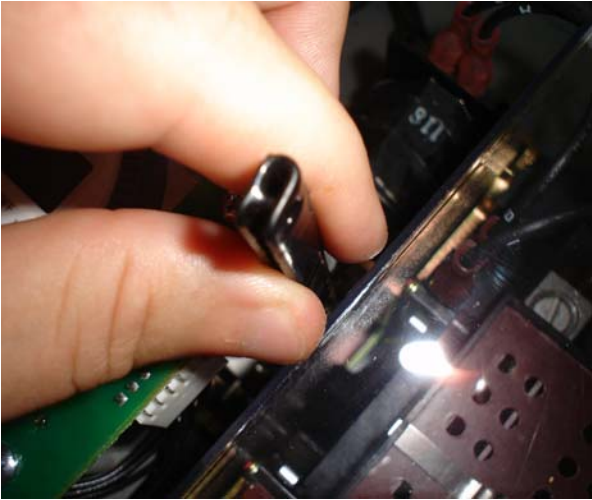

3. The flat side of the removable handle must face away from the power connection side of the switch mechanism as seen in the “Manual transfer handle position” photo below for easy transferring. With the removable handle in the proper direction it may be placed on the manual transfer lever location.

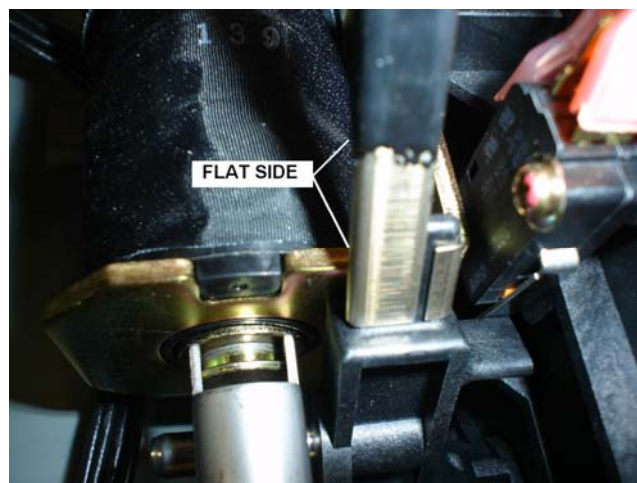

Manual transfer handle position

4. With the removable handle located on the manual transfer lever, the contactor may be transferred. Always remove the handle after each transfer in reverse order from the above steps.

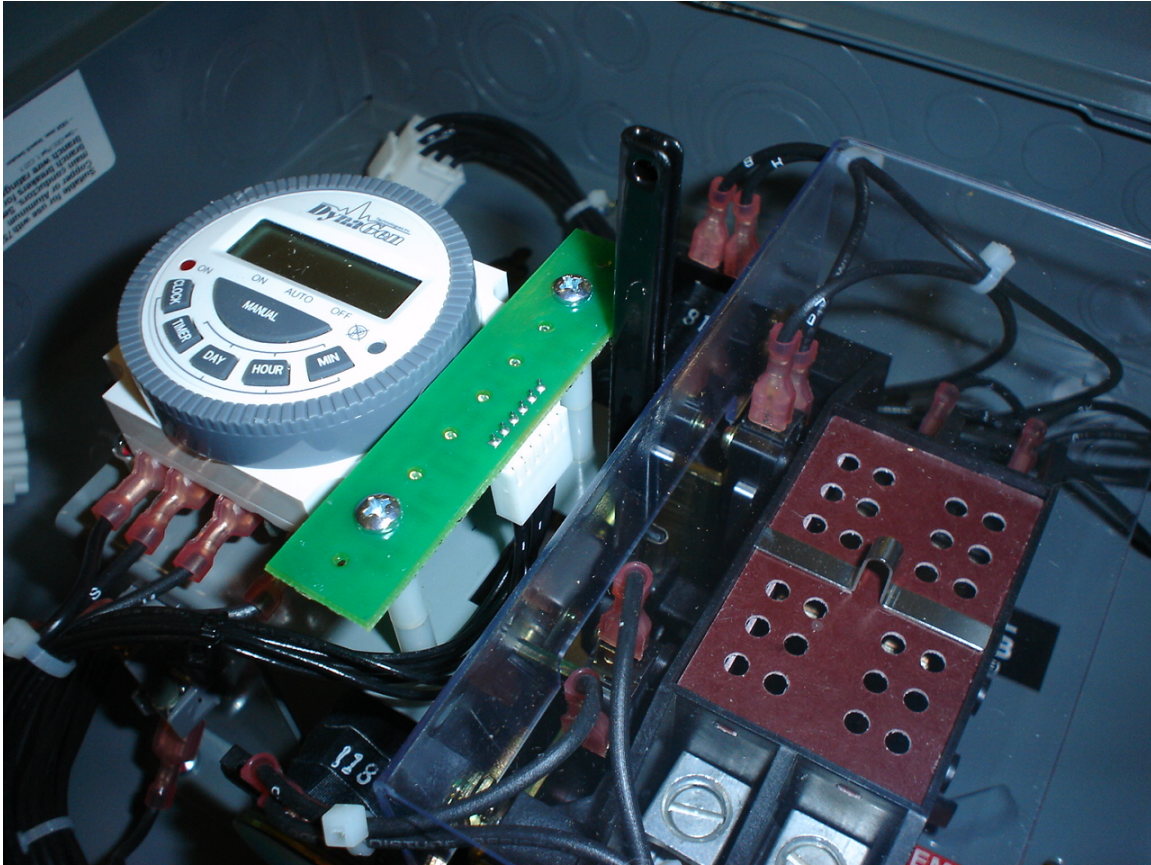

6:0 RECOMMENDED MAINTENANCE

 <p><u>WARNING:</u> When performing any maintenance of the mechanism, isolate the transfer switch from all possible sources of power.</p>



Periodically inspect all terminals (load, line and control), and all fasteners for any loose parts or wiring.

Test the transfer switch operation upon initial installation. Periodically check for any excessive wear on any mechanical operating parts or wiring connections. Clean or replace parts when necessary.

All transfer switch parts are made of corrosion resistant material or is plated, coated or painted for corrosion protection.

Procedure	Action
Making the transfer switch safe for inspection and maintenance.	Disconnect all possible power sources before switch inspection.
Inspect transfer switch location for possible safety issues	Inspect mounting location for any safety or fire issues. Inspect for dirt, wiring damage and mechanical damages.
Inspect transfer switch for loose hardware.	Check all hardware including controller, exerciser, terminals etc. for any looseness due to vibrations etc.
Check for any overheating due to loose connections	Check for any discoloration, melting or blistering of any wiring or connections
Perform regular testing of transfer switch	Perform regular testing of the switch to check for proper operation in case of emergency

7:1 Vigilant 100A Load Center General Arrangement

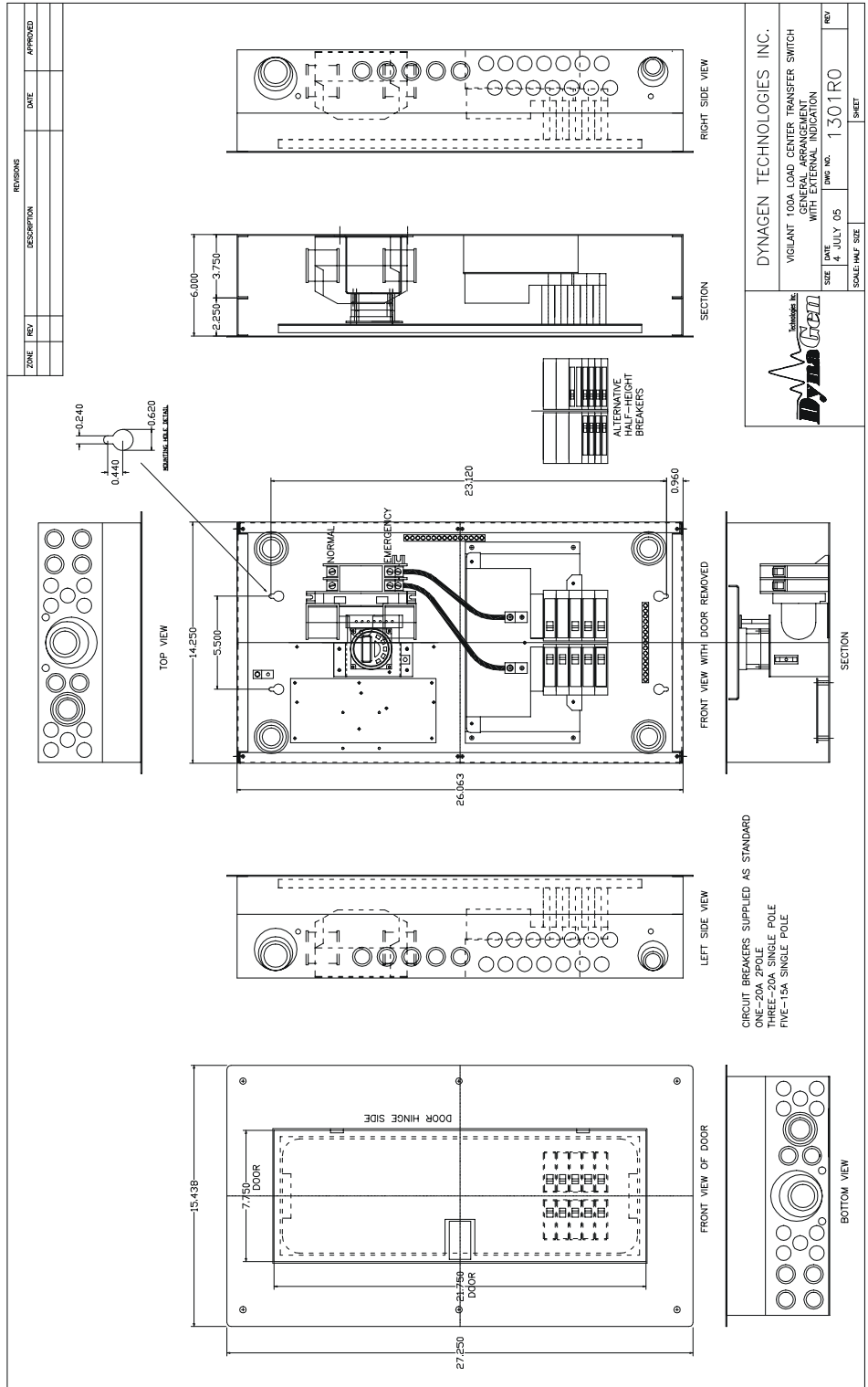

7:2 Vigilant 100A Load Center Wiring

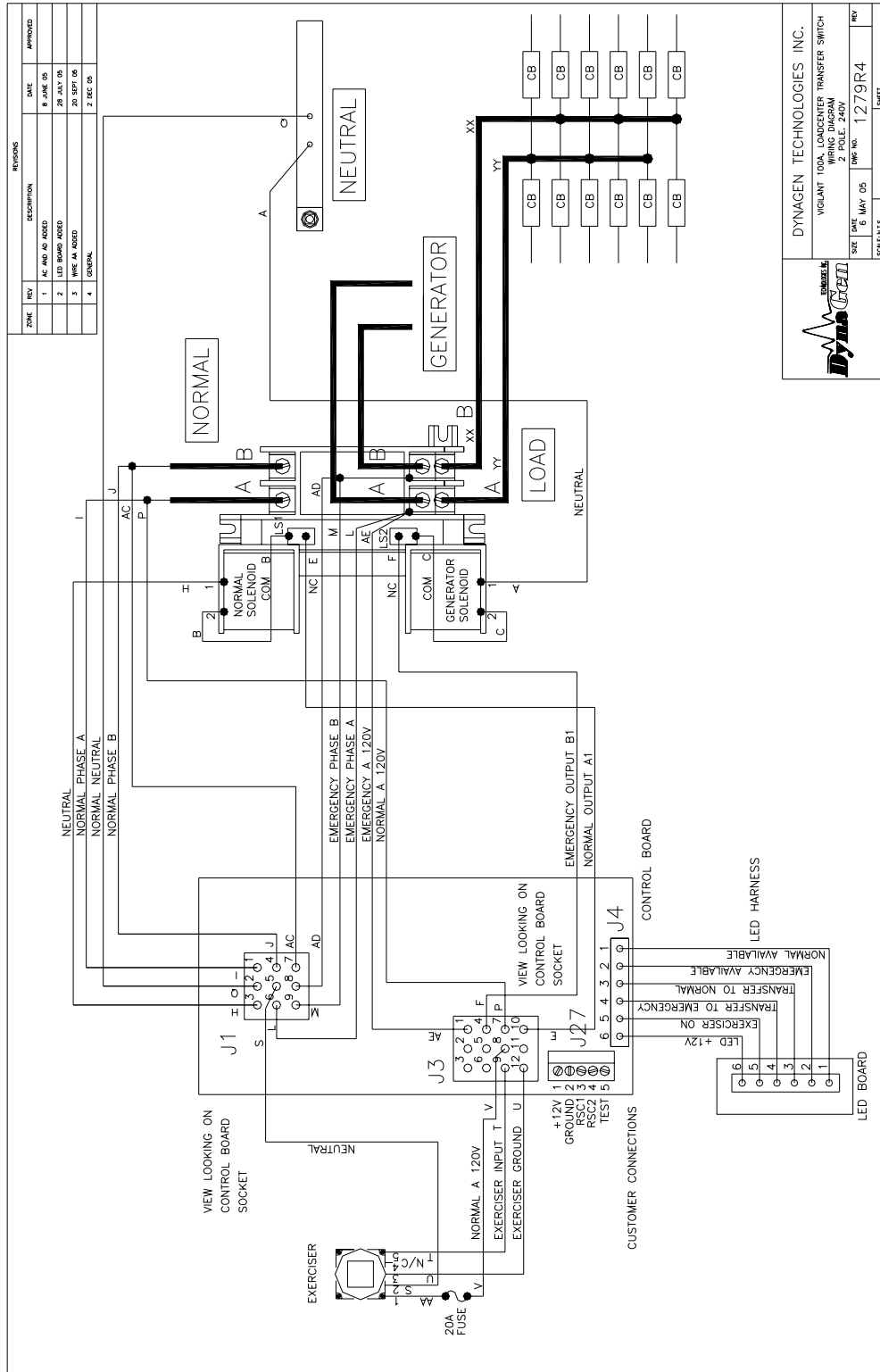

ZONE	REV	DESCRIPTION	DATE	APPROVED
	1	AC AND AD ADDED	8 JUNE 05	
	2	LED BOARD ADDED	28 JULY 05	
	3	WIRE AS ADDED	20 SEPT 06	
	4	GENERAL	2 DEC 05	

DYNAMEN TECHNOLOGIES INC.
VIGILANT 100A LOADCENTERS TRANSFER SWITCH
WIRING DIAGRAM
2 POLE, 240V

DATE	0 MAY 05	REV	
SIZE	D	DWG NO.	1279R4
DRAWN BY		CHECKED BY	
SHEET		SHEET	

8. ENGINE EXERCISER AND EXTERNAL LED ANNUNCIATION

Introduction

All Vigilant 2000 series transfer switches include an external engine exerciser and LED annunciation. The engine exerciser is easily adjustable from outside the transfer switch enclosure. External LED indication is included on all Vigilant 2000 series switches allowing visual controller status. The user may set the engine exerciser to simulate a utility power failure and test the functionality of the transfer switch system. The exact day and time may be specified for testing. External LED indication is available for normal available, emergency available, transferred to normal, transferred to emergency and exercise/test run illumination is explained in detail in the VTSC100 user manual. The functions of the exerciser time clock are described below. The exercise time clock is used to set specific times to test the transfer switch operation. The exerciser is protected using a 20A fuse. The RESET BUTTON initializes the time clock erasing any previous program. The following will explain how to:

1. Set current time and date
2. Set program timing
3. Review your program
4. On/Auto/Off mode



NEMA 1

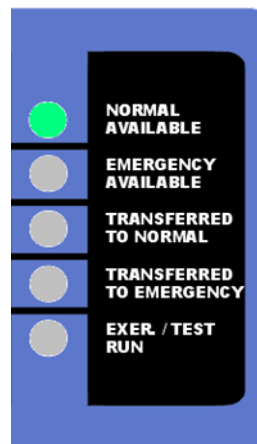

Set current time and date:

1. Press Clock and Day buttons until current day shows. Release both buttons for current day setting.
2. Press Clock and Hour buttons until current hour shows. Release both buttons for current hour setting.
3. Press Clock and Min buttons until current minute shows. Release both buttons for current minute setting.
4. After setting the weekday and time, the seconds will be set automatically.

Set program timing:

1. Press timer button on the exerciser clock. The “1ON” will appear at the left side of the display. The “1ON” represents when the testing start will begin.
2. Press Day button to select the program day period. There are 10 possible choices to choose from which can be selected by repeatedly pressing the Day button. The 10 possible selections are:
 1. Mo. to Su.
 2. Mo.
 3. Tu.
 4. We.
 5. Th.
 6. Fr.
 7. Sa.
 8. Su.
 9. Mo. to Fr.
 10. Sa. to Su.
3. Press Hour button to set hour.
4. Press Min button to set minute.
5. After setting the above testing start time, press the Timer button. After pressing the Timer button the “1OFF” will appear at the left side of the display. The “1OFF” represents when the testing will end.
6. Repeat the above steps 2, 3 and 4 to set the time when the system test is to end.
7. The exerciser timer gives the user 6 different start and end set times if required.

Program review:

1. Repeatedly press Timer button to advance display to each subsequent “On” or “Off” user settings.
2. The user set Days and Times will be displayed.
3. To make a change in a specific setting, Repeat Set Program timing above.

On/Auto/Off mode:

1. The On/Auto/Off mode may be selected by pressing the manual button.
2. When the On mode is selected, the transfer switch will go directly to the test mode. The test mode will stay active until the On mode is not selected.
3. When the Auto mode is selected, the timer will monitor the user settable program times. The transfer switch will be tested using the programmed start and end times.
4. When the Off mode is selected, the timer will not monitor any user settable program times. The exerciser will not signal to start the generator when it is in the “off” mode.

Please note:

When the transfer switch is not connected to an energized utility source, the exerciser timer will use an internal battery for memory storage. With the exerciser in the OFF position very little current draw is required. With the exerciser in the ON position a larger current draw is required. With the exerciser in the AUTO position very little current draw is required when the program is not initiated. See chart below for internal battery current draw:

Exerciser Position	Current Draw
ON	80 uA/Hour
OFF	5 uA/Hour
AUTO (program not initiated)	5 uA/Hour
AUTO (program initiated)	80 uA/Hour

The internal battery current draw would not be applicable when an energized utility source is supplying power to the switch.

SERVICE NOTES-LOAD CENTER

<u>CONTENTS</u>	<u>PAGE</u>
Replacement Parts Identification._____	33
Wiring Diagram and Wiring Harness Identification._____	33
Control Board Replacement._____	34
Switch unit Replacement._____	35
Switch Lug Replacement._____	37
Timer Replacement._____	38
LED Board Replacement._____	38
Wiring Harness Replacement._____	38

REPLACEMENT PARTS Figure 1

The listing below identifies replacement parts. Order by using the description and stock code number.

<u>Description</u>	<u>Stock Code Number</u>
<u>100A Contactor</u>	<u>SWT0038</u>
<u>Load Center Control Board 12 volt</u>	<u>VTSC100-240-12-X</u>
<u>Load Center Control Board 24 volt</u>	<u>VTSC100-240-24-X</u>
<u>100A Contactor Lugs</u>	<u>CON0121</u>
<u>Timer</u>	<u>ACC0073</u>
<u>LED Board</u>	<u>VTS-ANNL</u>
<u>Wiring Harness</u>	<u>DWG1280R5</u>

It is recommended that after completing any of the following procedures, a test be performed to verify the proper operation of the transfer switch.



WARNING: When replacing any parts of the mechanism, isolate the transfer switch from all possible sources of power.



Figure 1. REPLACEMENT PARTS

TO REPLACE THE CONTROL BOARD

First, make certain that the load center is disconnected from all power and control sources.

Remove the front cover/door assembly.

Unplug all the connections to the control board. The green 5-pin connector pulls straight out. The white 9 and 12-pin connectors pull straight out by gripping the connectors such that the top and bottom locking clips on each connector are released by this action. Disconnect the 6-pin connector at the bottom of the control board.

Remove seven screws securing the control board to the enclosure. Figure 2.

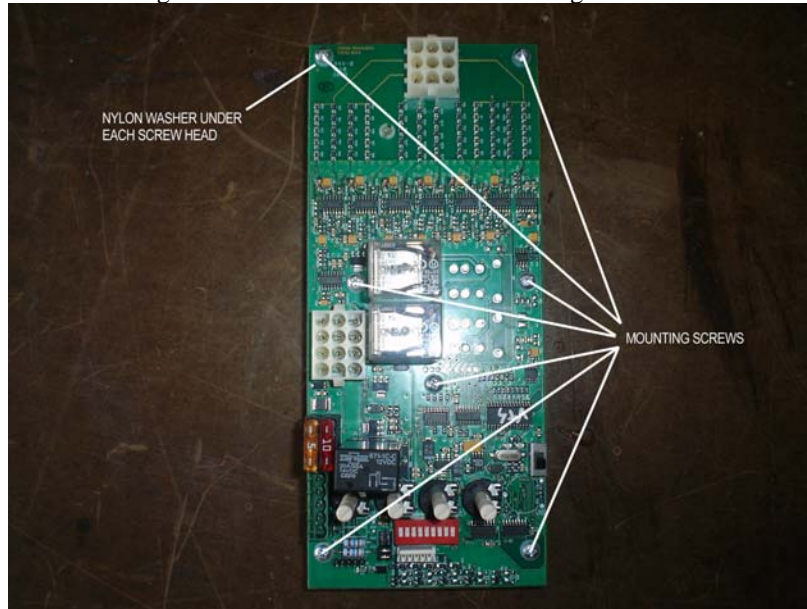

Figure 2. CONTROL BOARD MOUNTING SCREW LOCATIONS

The control board can now be removed from the enclosure.

Remove each screw, spacer and nylon washer from the old board, and replace in the new board. Do not forget the single self retaining nylon spacer. Figure 3.

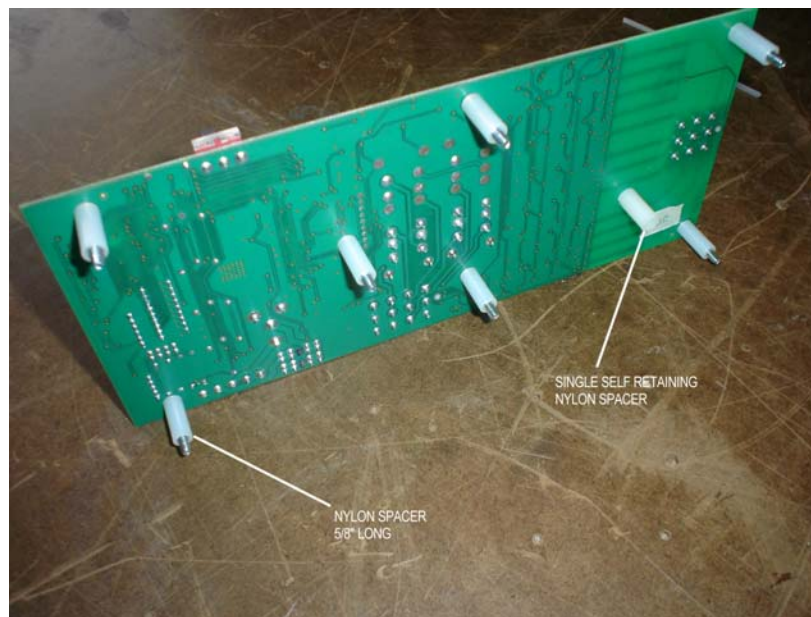

Figure 3. CONTROL BOARD NYLON SPACERS

The replacement control board can now be installed by following this procedure in the reverse order. Note the orientation of the control board when installing. The white 9-pin socket is at the top. Align the control board with the mounting holes. Tighten the screws evenly to avoid undue stress on the circuit board. Tighten to 5in-lb max.

TO REPLACE THE SWITCH UNIT

First, make certain that the load center is disconnected from all power and control sources.

Remove the front cover/door assembly.

Unfasten, but do not remove two screws securing the transparent switch cover. Figure 4.



Figure 4. TRANSPARENT COVER SECURING SCREWS

The cover has slots which fit over the screws, so it is not necessary to completely remove them in order to remove the cover. The switch cover can now be lifted clear.

Remove four screws securing the timer/led board support, and swing clear to access one of the screws securing the switch unit. Figure 5.

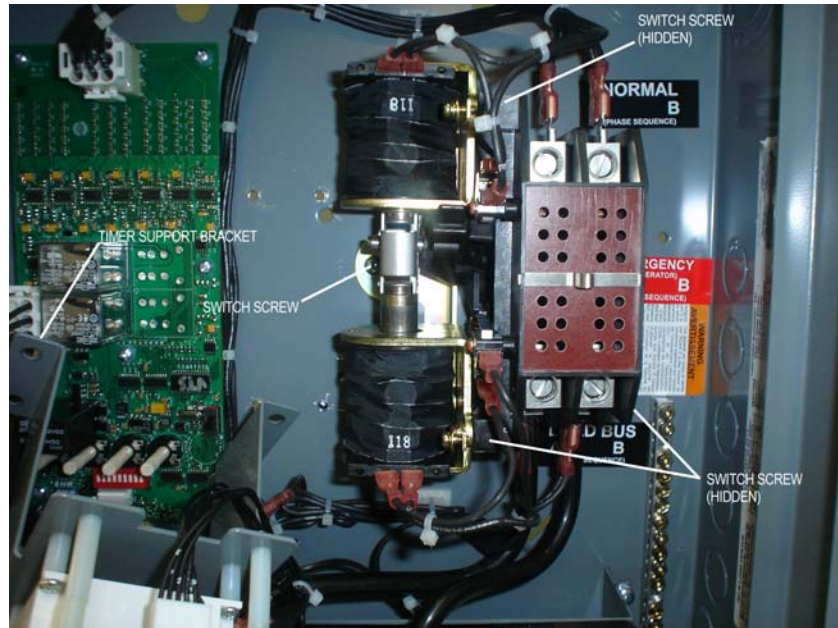

Figure 5. MOVED TIMER SUPPORT AND SWITCH SCREWS

Disconnect all the power and control wiring connections to the switch. Carefully withdraw the power cables from the switch terminals.

Remove four screws securing the switch unit to the enclosure. The switch unit can now be removed from the enclosure. Figure 5.

Follow this procedure in the reverse order to install a replacement switch unit. Do not exceed 25in-lb torque when replacing the switch and timer support screws.

Confirm all wiring connections by consulting the wiring diagram. The individual wires are identified at each end. Note the wire connections to the two limit switches shown in figure 6.

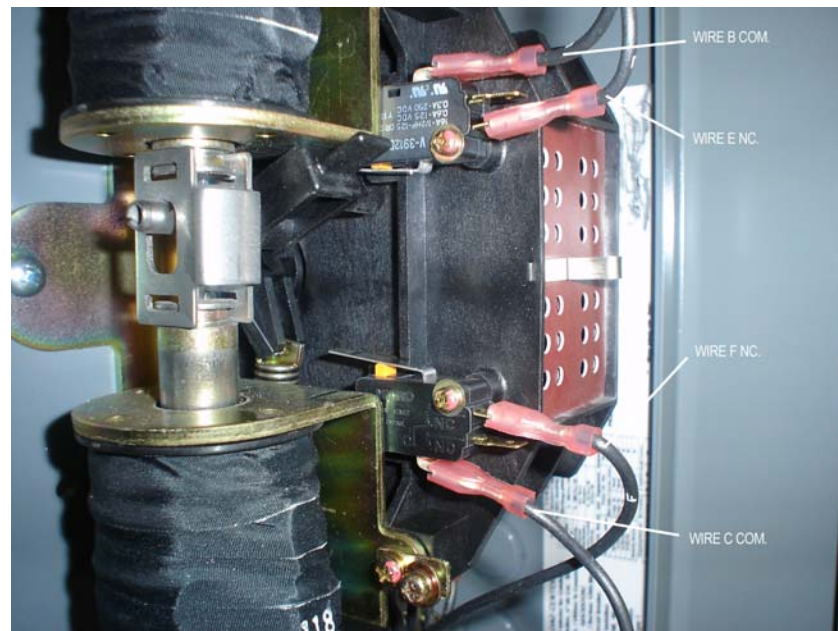

Figure 6. LIMIT SWITCH CONNECTIONS

TO REPLACE THE SWITCH LUGS

Remove the switch as described above.

All the lug securing screws can be accessed from the underside of the switch unit. Figure 7. Use a #2 Phillips screwdriver to detach the lugs and spade terminal adaptors.

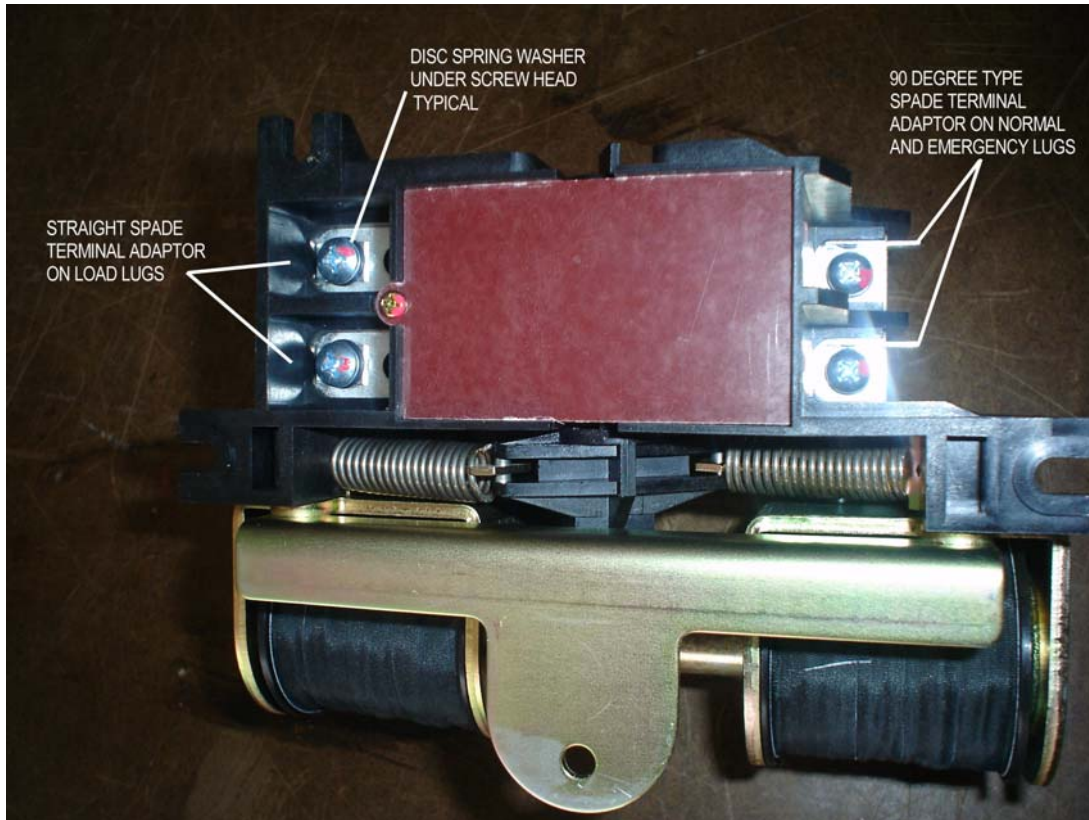

Figure 7. UNDERSIDE OF SWITCH SHOWING TERMINAL MOUNTING SCREWS

Re-assemble using the same hardware. The disc spring washer is assembled under the head of the screw, then the spade terminal adaptor. The end of the screw is then passed through the switch strap and screwed into the terminal lug. Note that the straight spade terminal adaptor is only used at the load lug locations. The normal and emergency spade terminal adaptors are the 90 degree type. Torque all the lug securing screws to 26 in-lb.

TO REPLACE THE TIMER UNIT

First, make certain that the load center is disconnected from all power and control sources.

Remove the front cover/door assembly.

Disconnect the timer wiring.

Remove four screws securing the timer to the support bracket and lift the timer off. Figure 8.

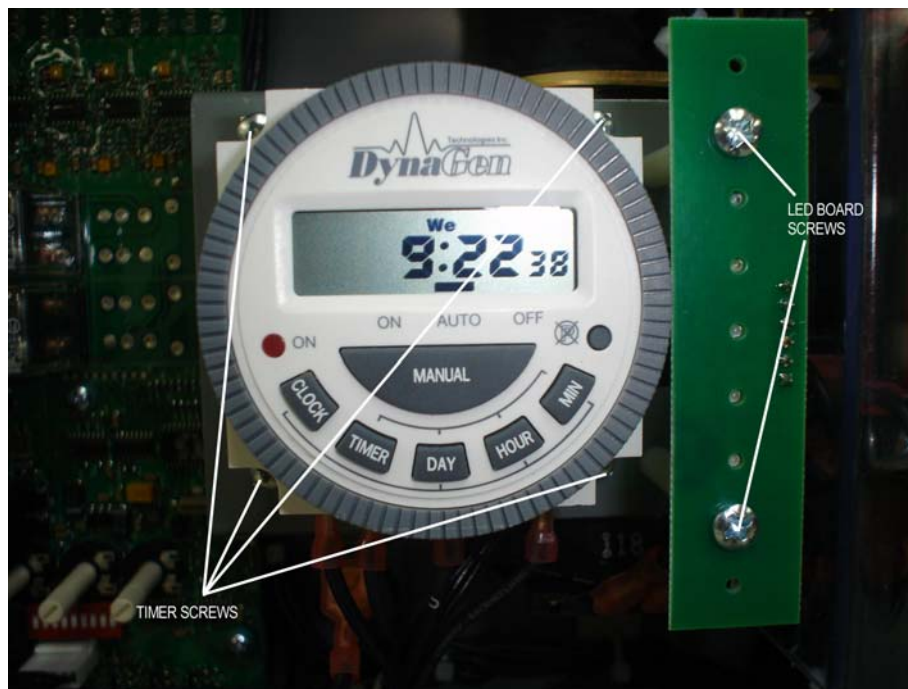

Figure 8. TIMER AND LED BOARD SCREWS

Re-use the four screws and spacers.

Follow this procedure in the reverse order to install a replacement timer unit. Do not exceed 5in-lb torque when replacing the timer screws.

TO REPLACE THE LED BOARD

First, make certain that the load center is disconnected from all power and control sources.

Remove the front cover/door assembly.

Unplug the LED board wire connector.

Remove two screws securing the LED board to the support bracket and lift the LED board off. Figure 8.

Re-use the two screws and spacers. Note that one 5/8" and one 1" long spacer are used on each screw.

Follow this procedure in the reverse order to install a replacement LED board. Do not exceed 5in-lb torque when replacing the LED board screws.

Note the orientation of the replacement board. The wire connector is on the right hand side.

TO REPLACE THE WIRING HARNESS

The replacement wiring harness is supplied as a complete unit, pre-formed as far as possible thus permitting a virtual "drop in" installation once the original harness is removed.

First, make certain that the load center is disconnected from all power and control sources.

Remove the front cover/door assembly.

Disconnect the white 9 and 12-pin connectors from the control board. Pull them straight out by gripping the connectors such that the top and bottom locking clips on each connector are released by this action.

Disconnect the 6-pin connector at the bottom of the control board.

Pull all the spade terminal connectors from both the switch unit and the timer. Remove the 6-pin connector from the LED board.

Use either #T20 Torx or #2 Phillips screwdriver to remove the screw securing the two neutral wire ring terminals to the right hand neutral bar. Figure 9.

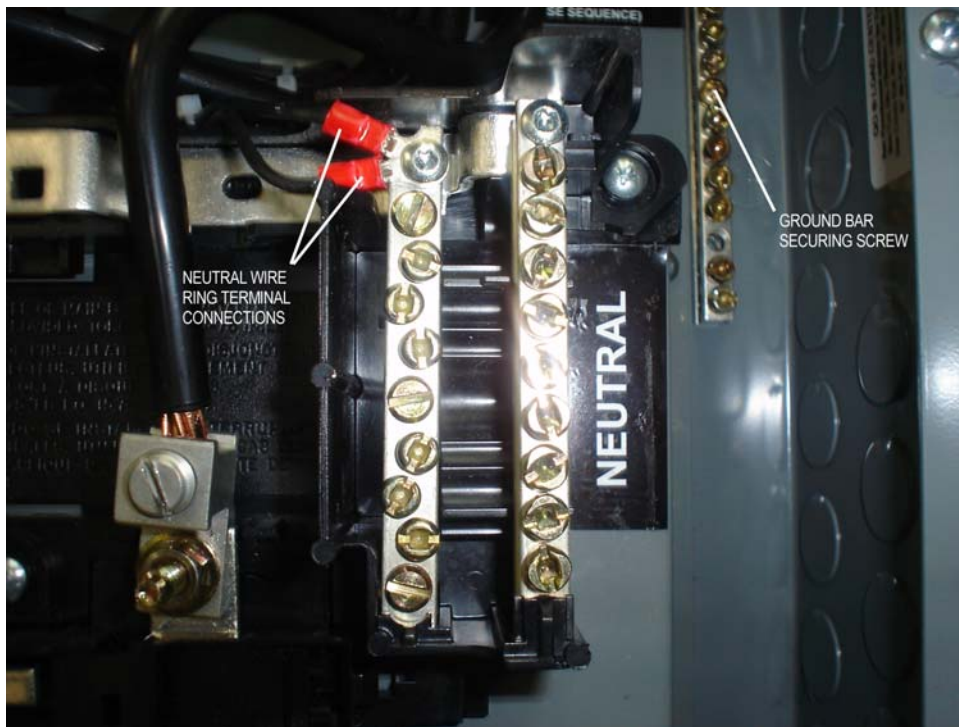

Figure 9. WIRE HARNESS NEUTRAL CONNECTIONS

Use wire cutters to sever the nylon wire ties to release the original harness at the tie rap base locations. Remove three screws holding the timer support bracket to permit it to be angled to allow the harness to pass between it and the control board. Note the general layout of the original harness before lifting it clear. Install the replacement harness with reference to the wiring diagram for the wire terminations. Each wire is identified with a letter on both ends. Check the installation and replace the nylon tie raps to secure the harness. Now follow the removal procedure in the reverse order after replacing the timer support bracket screws.

GROUND BARS AND GROUND LUG

The ground bars are secured to the enclosure with a single #2 Phillips head screw. Figure 8. The single ground lug located at the top of the enclosure is also secured with a single screw; either a #2 Phillips or slotted head type may be fitted. These components are normally not replaced.

NEUTRAL BARS

The neutral bars are secured to the insulated interior using either a single #2 Phillips screw or #T20 Torx type in each bar. By removing this screw, the bar may be released from the molded plastic interior. These components are normally not replaced.