



GSC400 Series

Automatic Engine Controller



GSC400 Automatic Engine Controller

Installation and User Manual

Full Version File: GSC400 Rev1.0.doc, Feb. 2006

Thank You For Purchasing This DynaGen Product

Please Read Manual Before Installing Unit

Receipt of Shipment and Warranty Return Information

Upon receipt of shipment, carefully remove the unit from the shipping container and thoroughly examine the unit for shipping damage. In case of damage, immediately contact the carrier and request that an inspection report be filed prior to contacting DynaGen.

All returned items are to be shipped prepaid and include a Return Material Authorization (RMA) number issued by DynaGen. RMA forms are available by contacting DynaGen Technical Support through the contact methods listed below.

Limited Warranty

DynaGen will repair or replace any GSC400 series engine controller which proves to be defective under normal and proper use within **Three Years** from the date of shipment. This constitutes the only warranty and no other warranty shall be implied.

We welcome your comments and suggestions. Please contact us at:

DynaGen Technologies Inc.
Phone: 1-888-396-2436
(902) 562 0133
Fax: (902) 567 0633
Email: support@dynagen.ca
WEB SITE: www.dynagen.ca

Table of Contents

GSC400 Series Specifications	4
1.0 GSC400 Product Series	5
2.0 Receiving, Handling, and Storage	6
2.1 Receiving:	
2.2 Handling	
2.3 Storage	
3.0 GSC400 Product Number Identification	7
4.0 GSC400 Series Installation and Wiring	8
4.1 General information	
4.2 Mounting location	
4.3 Connector Layout	
4.4 Connector Information	
4.5 AC Voltage Sensing	
4.6 AC Current Sensing	
4.7 AC Wiring Diagram	
4.8 DC Wiring Diagram	
4.9 Analog Input Wiring Diagram	
4.10 Digital Input wiring Diagram	
4.11 Connector Details	
5.0 GSC400 Modes of Operation	20
5.1 Off mode	
5.2 Auto mode	
5.3 Start mode	
6.0 GSC400 Menu System	21
6.1 GSC400 menu overview	
6.2 Clock setup	
6.3 Basic setup	
6.4 Advanced setup	
6.5 Failure history	
6.6 DefaultGSC400 Settings	
7:0 LED Status Indicators	48
7.1 LED indicator chart	
8.0 GSC400 Recommended Maintenance	51

GSC400 Specifications

DC Voltage Rating	12/24 VDC (Voltage Range 7 – 32 VDC)		
DC Power Cons.	25 mA @ 12 VDC		
Operating Temp	-40°C to +85°C (-40°F to +185°F)		
Function Selection Range	Function	Selection	Range
	Speed Sensing	Generator pickup Magnetic pickup	0-300vac, 0-3600rpm 0-300vac, 0-3600rpm
	Voltage Sensing	Single phase, Three phase, Delta, Wye	Max 700vac, +/- 1% Max 700vac, +/- 1% Max 700vac, +/- 1%
	Current Sensing*	Enable/Disable	Max 5A, +/- 1%
	Frequency Sensing	Enable/Disable	1 – 100 HZ
	Engine Temp	GND=Fail, Open=Fail	10-265°F, 10-265°C
	Oil Pressure	GND=Fail, Open=Fail	0-90 PSI, 0-90 Kpa
	Oil Level	GND=Fail, Open=Fail	0-90%
	Fuel Level	GND=Fail, Open=Fail	0-100%
	Engine Logic	Delay to start Pre-heat Crank Mid Heat Crank attempts False restart Post heat Warm-up Cooldown Crank oil pressure Crank Disconnect	0 – 60 seconds 0 – 60 seconds 3 – 60 seconds 0 – 60 seconds 1-60 tries Enable, Disabled 0 – 60 seconds 0 – 600 seconds 0-600 seconds 0-90 KPa 100-2000 RPM
	Analog Input	Input 2, 5-7 (High) Input 3-4 (Low)	Gnd=Fail, Open=fail 7mA Max
	Digital Input	Input A-D (Sw to Bat) Input E-H (Sw to Gnd)	Bat=Fail, 7mA Max Gnd=Fail, 7mA Max
	Digital Output	Output A-H Extra Relay	300 mA Max 40A Max
	Exerciser	Enable, Disable	10-240 Minutes
	Battery Recharge	Enable, Disable	10-240 Minutes
	Password	4-Digit	0-9
	LCD Display	128x64 Graphic display, Backlit, 60° viewing angle, LCD operating temperature -30°C to +60°C (-22°F to +140°F)	
LED Display	Red, Green, Yellow LED representation, Daytime Visible, 60° viewing angle		
Programming	Manual, Software, Field upgradeable		
J1939 Interface	Low emission capable		
Relays	Replaceable 40A relays for Crank, Fuel, Extra output.		
Dimensions	W x H x D , 139 x 113 x 65 mm (5.47 x 4.45 x 2.56 in.)		
Weight	0.45 Kg (1.0 Lb)		

*Use of Industry Standard CT Required.

1:0 GSC400 Controller Series:

The GSC400 automatic engine controller is specifically designed for advanced monitoring of power generation systems. The GSC400 monitors engine logic features as well as engine characteristics.

The GSC400 automatic engine controller's advanced circuitry is specifically designed to monitor engine logic. Engine logic consisting of the start and safe shutdown of the engine are included in the GSC400 and is user adjustable allowing preference settings of options and timing. The engine controller will control the starting of the engine, delays, cranking, false restarts etc. Engine shutdowns are monitored allowing delays and cool down periods. The GSC400's engine logic features will allow engine protection in the event of abnormal starting /stopping sequences.

The GSC400 will continuously and effectually monitor engine characteristics. Engine characteristics such as temperature, pressure, RPM, voltage, current and coolant levels are closely monitored to protect the engine from any malfunctions. The GSC400 can be user adjustable to sound an audio alert to warn when a malfunction is in progress before actually shutting down the engine. The GSC400 will automatically shutdown the engine, depending upon the user settings, before any damage is afflicted to the engine.

All GSC400 automatic engine controllers incorporate an LCD display and LED indications. The LCD is used for multi-tasks including displaying dates, time, menu settings, status readouts etc.

GSC400 Front View



GSC400 Back View

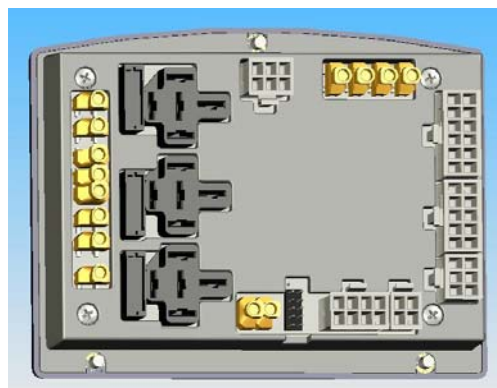

2:0 Receiving, Handling, and Storage



Receiving:

Every effort is made to ensure that your GSC400 engine controller arrives at its destination undamaged and ready for installation. The packing is designed to protect the GSC400 internal components as well as the enclosure. Care should be taken to protect the equipment from impact at all times. Do not remove the protective packaging until the equipment is at the installation site and ready to be installed.

When the GSC400 reaches its destination, the customer should inspect the shipping box and controller for any signs of damage that occurred during transportation. Any damage should be reported to a DynaGen representative once a thorough inspection is complete.

A shipping label affixed to the shipping box includes a variety of product and shipping information, such as items and Customer numbers. Make certain that this information matches your order information.

Each GSC400 controller is packaged in its own box. Do not discard the packing material until the controller is ready for installation.

Important documents will be found inside the GSC400 controller protective packaging box including the GSC400 user and installation manual and system wiring diagrams.



Handling:

As previously mentioned, each GSC400 engine controller is packaged in its own individual box. Protect the equipment from impact at all times and do not carelessly stack. Once the controller is at the installation site and ready to be installed, the packaging material may be removed.



Storage:

Although well packaged, this equipment is not suitable for outdoor storage. If the GSC400 is to be stored indoors for any period of time, it should be stored with its protective packaging in place. Protect the controller at all times from excessive moisture, dirty conditions, corrosive conditions, and other contaminants. It is strongly recommended that the package-protected equipment be stored in a climate-controlled environment of -20 to 65°C (-4 to 149°F), with a relative humidity of 80% or less. Do not stack other equipment on top of the stored controllers.

3.0 GSC400 Product Number Identification:



The GSC400 series product numbering scheme provides significant information pertaining to a specific model. The product Number Identification Table (see Table 1) provides the required interpretation information. An example is offered to initially simplify the process.

A product number GSC400-X-XX-XX would consist of a combination of information from the following table.

TABLE1: IDENTIFICATION TABLE

Position 1-6	Position 8	Position 10-11	Position 13-14
Series	Speed Range	DC Voltage	Labeling
GSC400=GSC400	L=Low H=High	12=12VDC 24=24VDC	LS=Standard LX=Customized

Example: The product number GSC400-H-12-LS would be described as follows:

A GSC400 series automatic engine controller configured for a 12 VDC system. The controller is factory configured for high speed range (magnetic speed range) which includes standard labeling.

A GSC400 serial number would be displayed as:

GSC400-H-12-L1-00000

4:0 GSC400 Series Installation and Wiring:

DANGER HIGH VOLTAGE	<h1 style="margin: 0;">WARNING</h1>	DANGER HIGH VOLTAGE
<p>The GSC400 may carry high Voltage/Current which can cause serious injury or death. Extreme caution must be exercised when connections are being installed to or from the controller. All wiring connections must be de-energized before any installations are performed. Wiring of the GSC400 should be performed by qualified electricians only.</p>		

4:1 General Information:

All GSC400 engine controllers are factory tested and approved. Customer installation requires the mounting of the controller as well as all external wiring for normal operation. Once the GSC400 engine controller is properly installed, it should be visually inspected and approved before any testing is performed.

4:2 Mounting Location:

The GSC400 engine controller must be properly mounted for safe operation. Caution must be taken at the installation site to make sure the site is free from excessive moisture, fluctuating temperature ranges, dust, corrosive materials etc. The controller should be safely mounted in a secure location using the 3 mounting screws provided. See mounting location in figure 1.

Figure 1 – GSC400 Mounting Locations



Caution: Mounting screws must be installed at the recommended torque of 10 inch pounds.

4:2.1 GSC400 Mounting Dimensions:

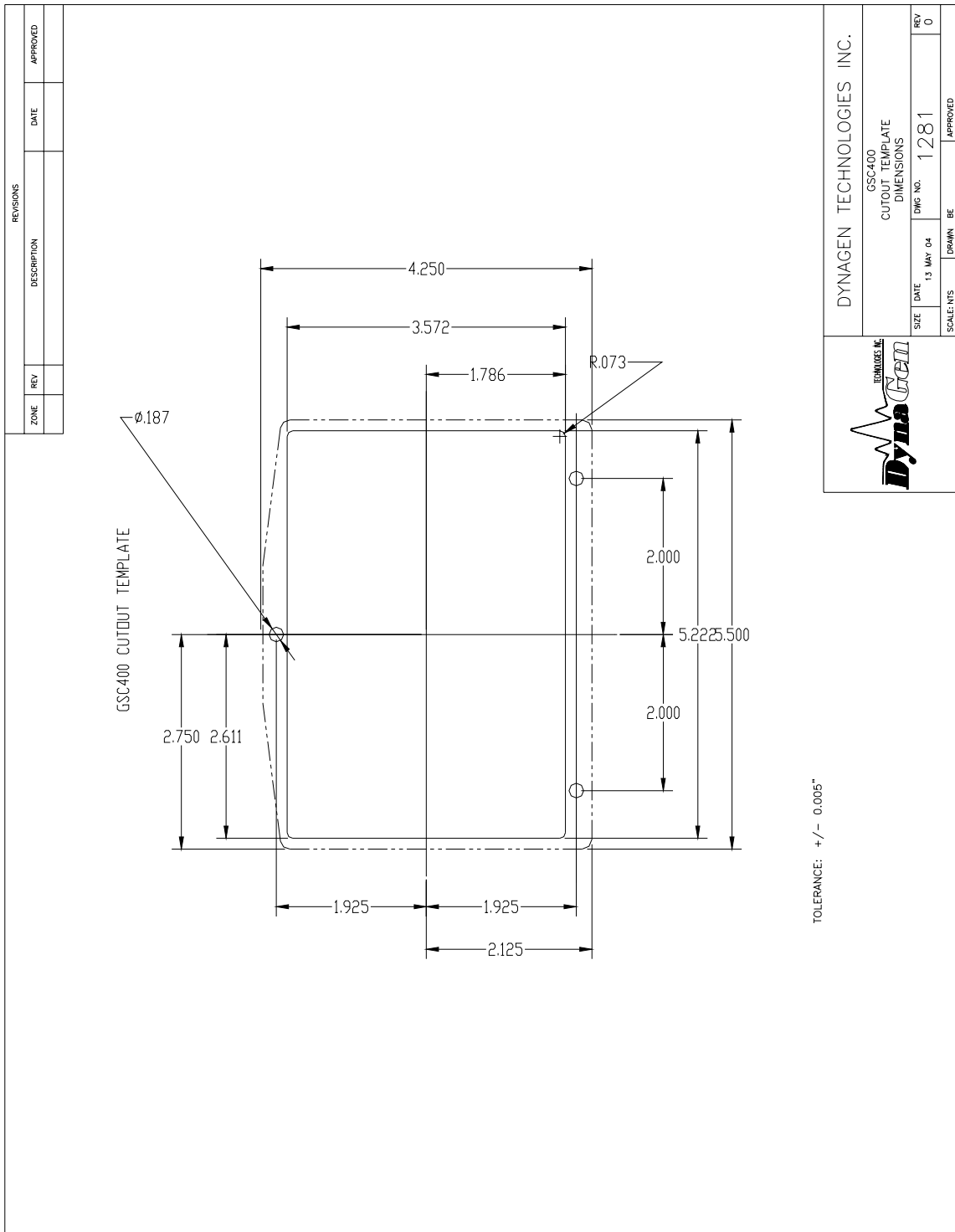

4:3 GSC400 Typical Connector Layout:

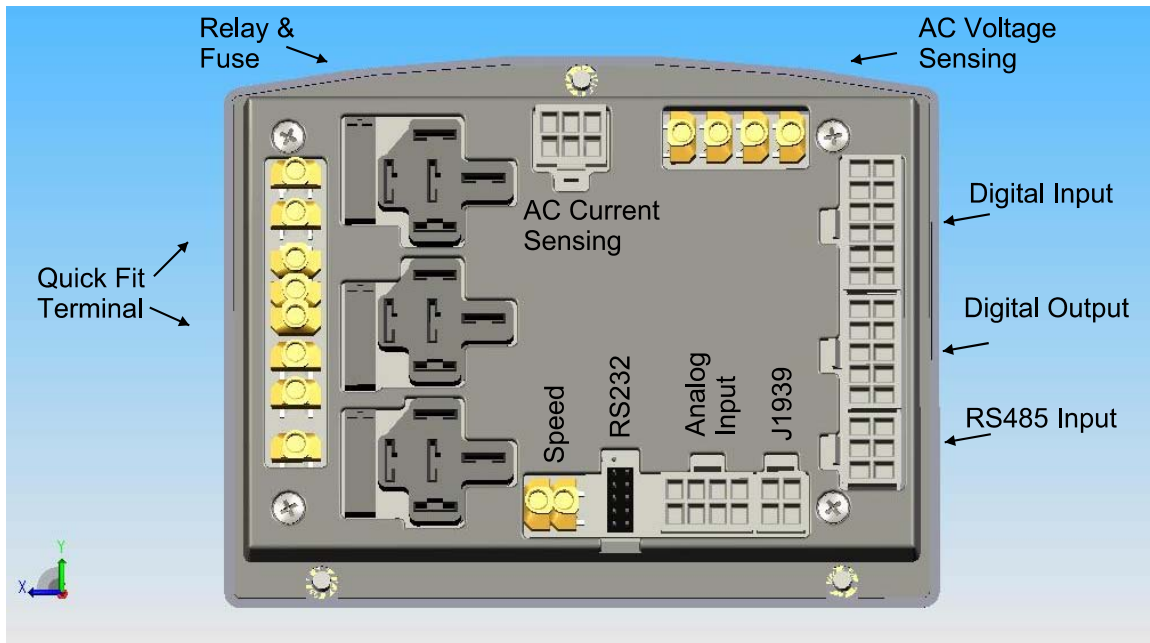

Electrical Installation Note

Many electrical connections need to be installed to the GSC400 for proper operation. Wire harnesses and/or wire harness plug connectors may be supplied to the customer upon request. Wire harnesses/connectors would include:

- Two (2) – 6-position connectors (2x3) for AC current sensing and RS485 Input.
- One (1) – 4-position connector (2x2) for J1939.
- One (1) – 8-position connector (2x4) for Analog Input.
- One (1) – 10-position connector (2x5) for Digital Output.
- One (1) – 12-position connector (2x6) for Digital Input.

Additionally there are several 1/4" blade type quick connect terminals for the higher voltage/current connections. Quick connects would include:

- Two (2) – Quick connects for speed sensing.
- Four (4) – Quick connects for AC voltage sensing.
- Four (4) – Quick connects for power connection.
- Four (4) – Quick connects for Fuel, Crank and extra relay connection.

4:4 GSC400 Typical Connector Information:

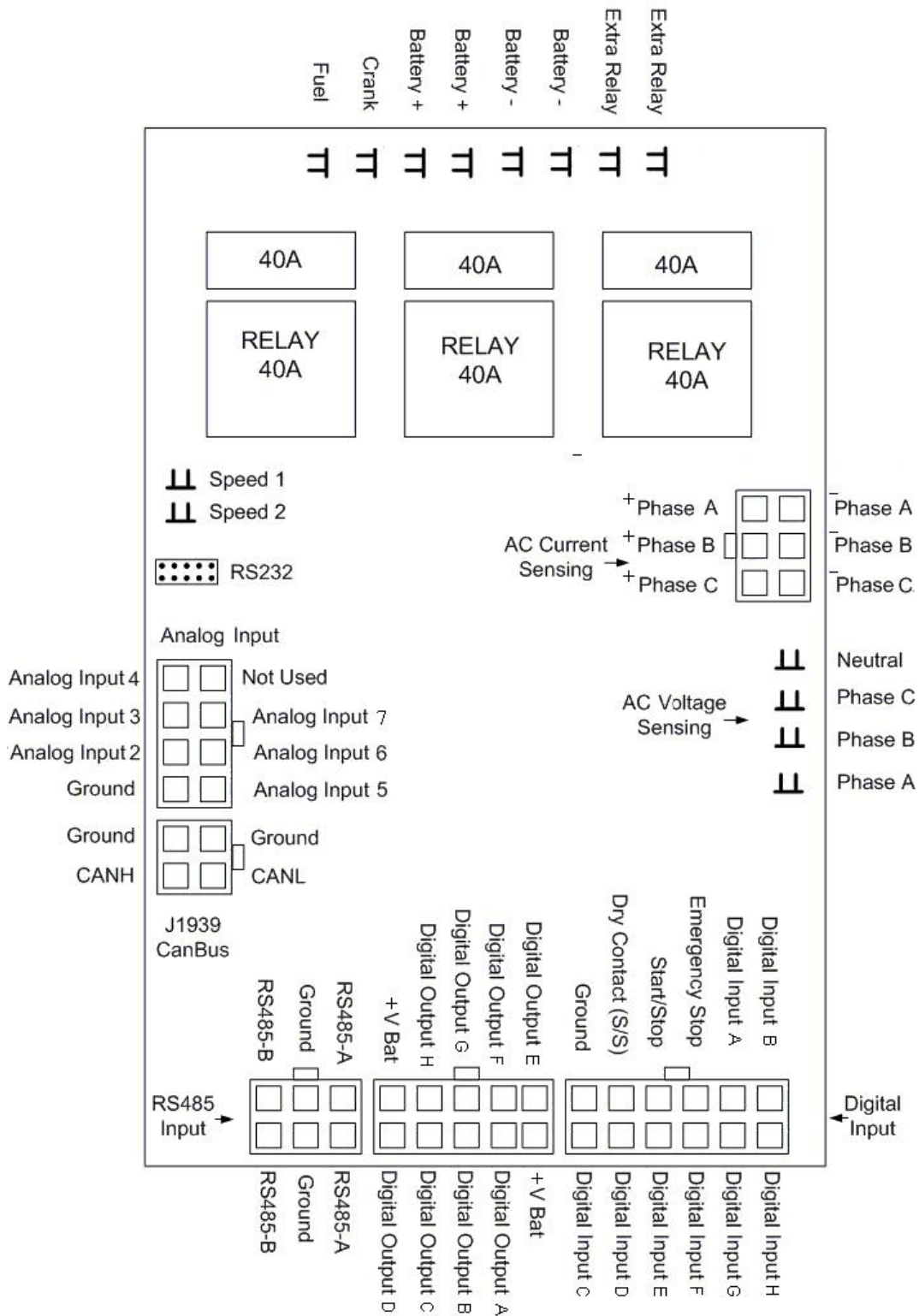

4:5 GSC400 AC Voltage Connection:

DANGER HIGH VOLTAGE	<h1 style="margin: 0;">WARNING</h1>	DANGER HIGH VOLTAGE
AC power may carry high Voltage/Current which can cause serious injury or death. De-energize all AC power sources before any connections are performed.		

AC electrical connections need to be applied to the GSC400 for proper AC voltage sensing. AC power is supplied to the AC Voltage Sensing blade terminals located on the GSC400. Connections would be installed as follows:

In single phase applications

- Phase A to terminal Phase A
- Phase B to terminal Phase B
- Neutral to terminal Neutral

In three phase applications

- Phase A to terminal Phase A
- Phase B to terminal Phase B
- Phase C to terminal Phase C
- Neutral to terminal Neutral

In center tapped delta applications

- Phase A to terminal Phase A
- Phase B to terminal Phase B
- Phase C to terminal Phase C
- Neutral to terminal Neutral

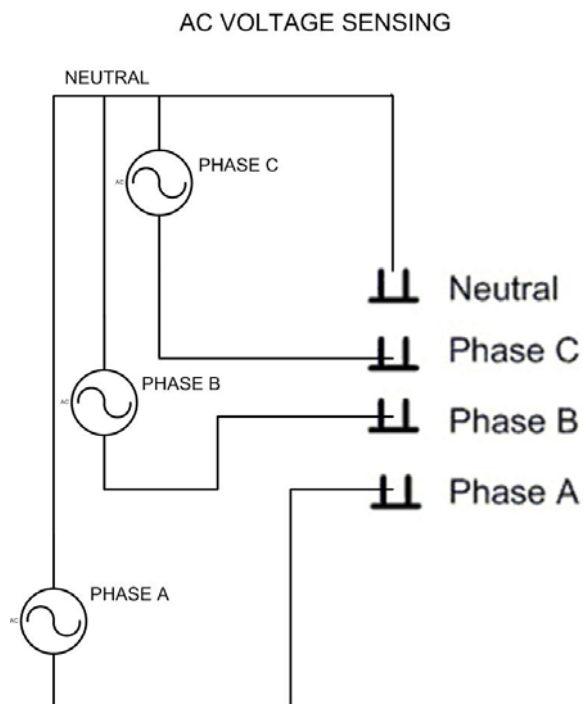

4:6 GSC400 AC Current Sensing:

DANGER HIGH VOLTAGE	<h1 style="margin: 0;">WARNING</h1>	DANGER HIGH VOLTAGE
AC power may carry high Voltage/Current which can cause serious injury or death. De-energize all AC power sources before any connections are performed.		

Current transformers need to be applied to the electrical wiring between the power source and load connections for current sensing. Current transformers are supplied to the AC Current Sensing connector located on the GSC400. Connections would be installed as follows:

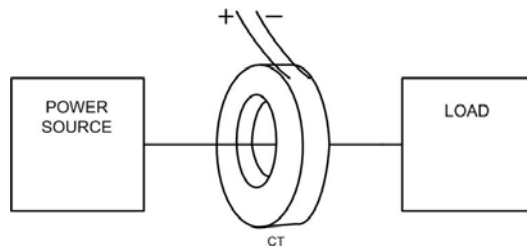

In single phase applications

- Phase A to terminals Phase A*

In three phase applications

- Phase A to terminals Phase A*
- Phase B to terminals Phase B*
- Phase C to terminals Phase C*

In center tapped delta applications

- Phase A to terminals Phase A*
- Phase B to terminals Phase B*
- Phase C to terminals Phase C*

*White wire assumed positive

*Black wire assumed negative

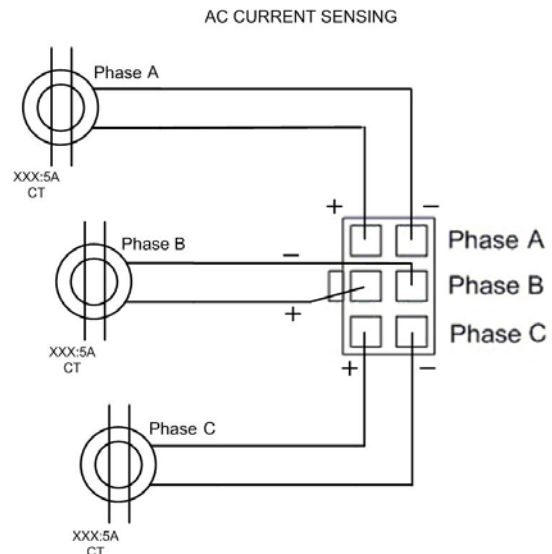

NEVER energize AC power with AC current sensing connector unplugged from GSC400. An energized unplugged connector could result in severe injury or death. Never unplug energized connector.

4:7 GSC400 AC Wiring Diagram:

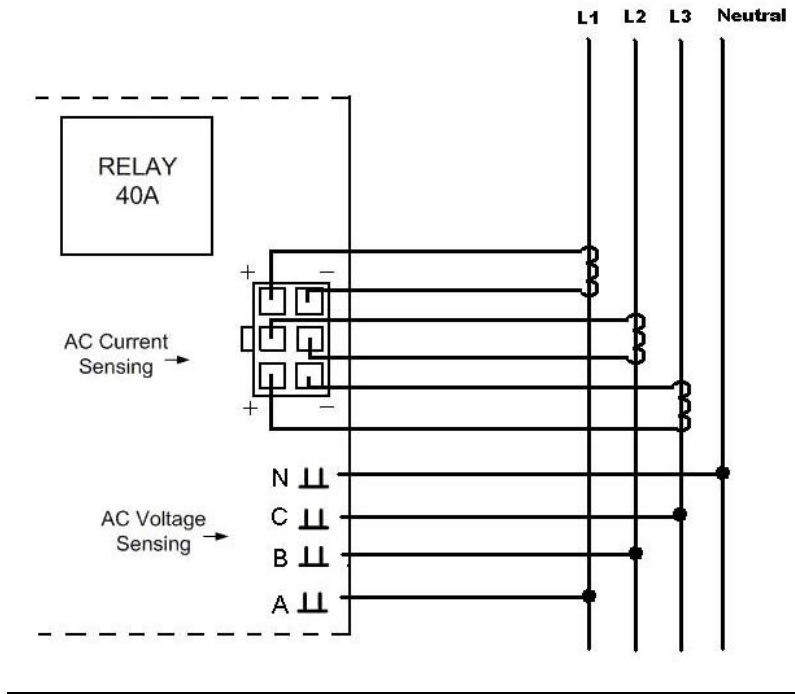

4:8 GSC400 DC Wiring Diagram:

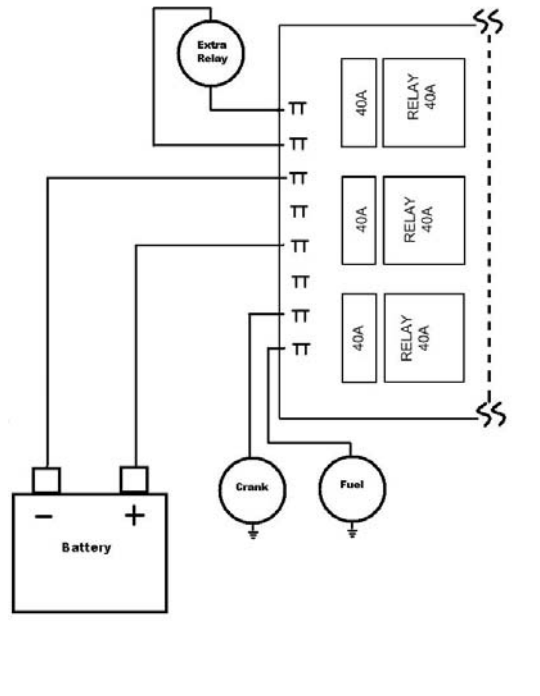

4:9 GSC400 Analog Input Wiring Diagram:

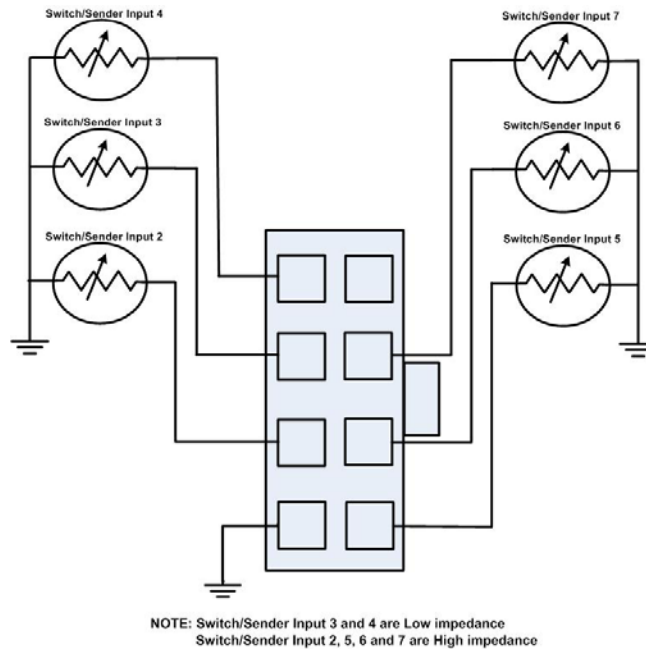

4:10 GSC400 Digital Input Wiring Diagram:

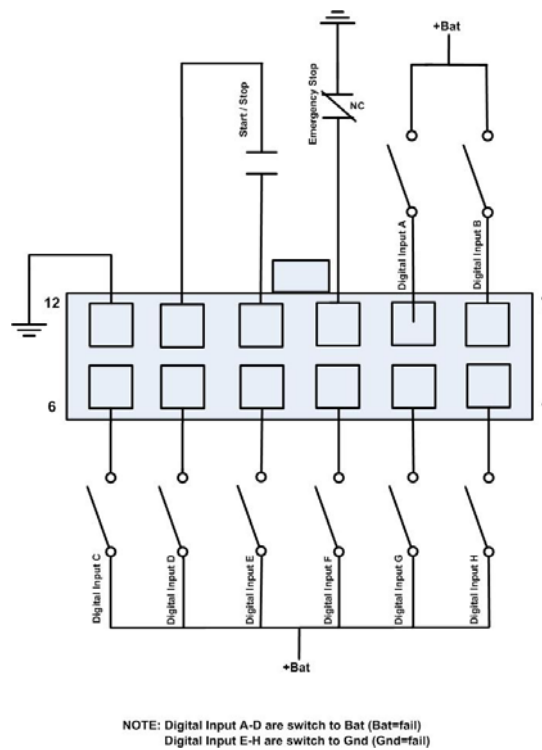

GSC400 Connector Details

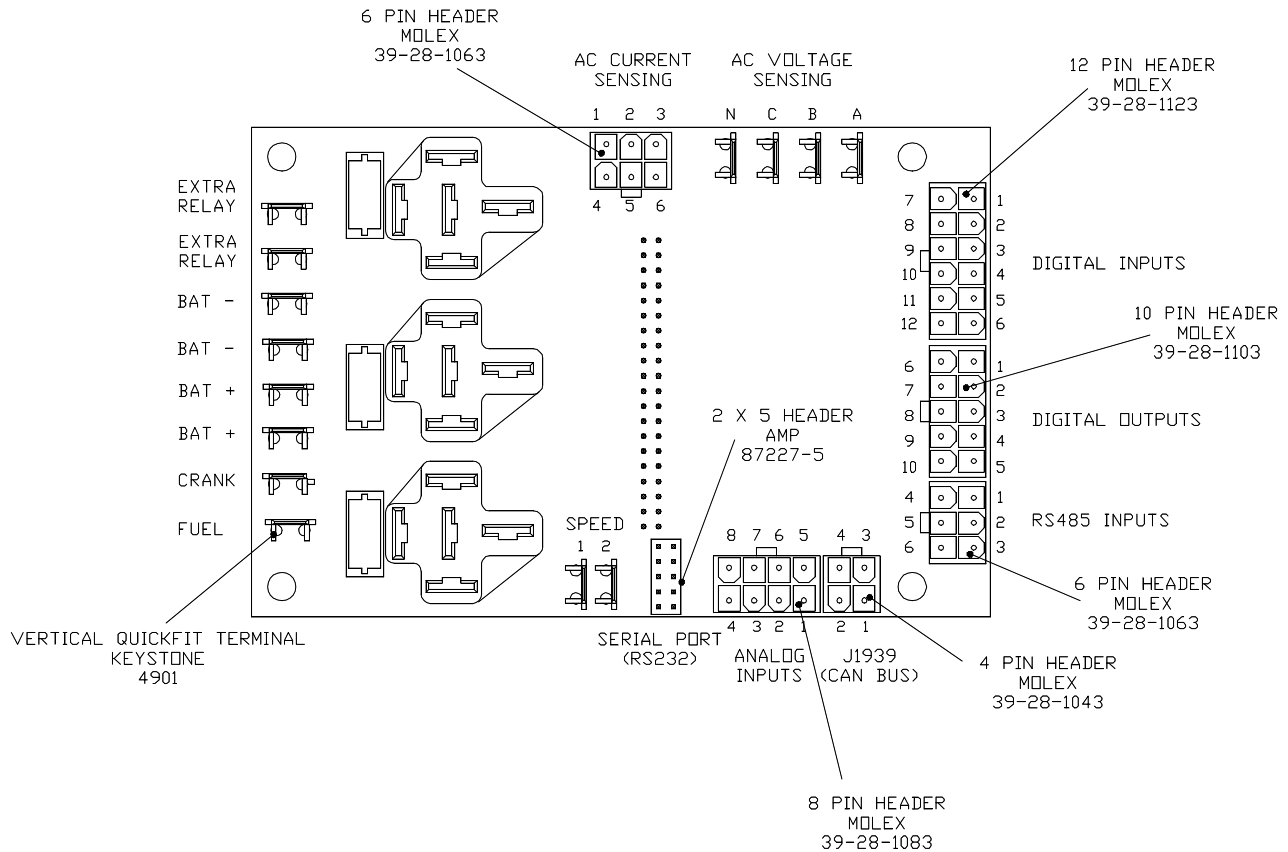

GSC400 Quick Fit Terminal

The GSC400 quick Fit terminals are used for high power connections. Controller relay outputs are also connected to the quick fit terminal section.

Terminal	Wire Size (AWG)	*Current max.	Function
Crank	12	40A	Crank Output Terminal
Battery +	12	40A	Positive Battery Terminal
Battery -	12	40A	Negative Battery Terminal
Fuel	12	40A	Fuel Output Terminal
Extra Relay	12	40A	Extra Relay Output Terminal
Speed 1	18	100mA	Speed Signal Connection
Speed 2	18	100mA	Speed Signal Connection

*Total controller current output (max 60A)

GSC400 Analog Input Connection

The GSC400 analog input connector is used to connect analog input devices to the controller such as switches or senders. Single wire switch/senders may be connected to the proper input terminal with grounding supplied at the sender itself. Two wire switch/senders must be grounded to the ground terminal on the connector. If more than two 2-wire switch/senders are used, sender grounds must be tied together at the ground terminal on the connector.

Terminal Detail	Terminal Location	Wire Size (AWG)	Current max.	Function
Ground	1	18	7mA	Ground Terminal Connection
Input 2 - High	2	18	7mA	Configurable ¹
Input 3 - Low	3	18	7mA	Configurable ²
Input 4 - Low	4	18	7mA	Configurable ²
Input 5 - High	5	18	7mA	Configurable ¹
Input 6- High	6	18	7mA	Configurable ¹
Input 7- High	7	18	7mA	Configurable ¹
Not Used	8	18	7mA	Not Used

¹Senders requiring high pull-up use input 2, 5, 6, 7 which use high impedance pull-up

²Senders requiring low pull-up use input 3, 4 which use low impedance pull-up

GSC400 Digital Input Connection

The GSC400 digital input connector is used to connect digital input devices to the controller such as senders. Single wire senders may be connected to the proper input terminal with grounding supplied at the sender itself. Two wire senders must be grounded to the ground terminal on the connector. If more than two 2-wire senders are used, sender grounds must be tied together at the ground terminal on the connector. Start/Stop and Emergency stop are energized to ground only.

Terminal Detail	Terminal Location	Wire Size (AWG)	Current max.	Function
Input H - GND	1	18	7mA	Configurable*
Input G - GND	2	18	7mA	Configurable*
Input F - GND	3	18	7mA	Configurable*
Input E - GND	4	18	7mA	Configurable*
Input D - BAT	5	18	7mA	Configurable*
Input C - BAT	6	18	7mA	Configurable*
Input B - BAT	7	18	7mA	Configurable*
Input A - BAT	8	18	7mA	Configurable*
Emer. Stop	9	18	7mA	Allows Manual Emergency Stop
Start/Stop	10	18	7mA	Allows Manual Start/Stop of Engine
Dry Con (S/S)	11	18	7mA	Dry Contacts of Start/Stop Relay
Ground	12	18	7mA	Ground Terminal Connector

*See Advanced Setup Menu Chart under Digital Input Setup for possible selections

Input 1-4 (switch to Bat) +Bat = fail, Input 5-8 (switch to Gnd) Gnd = fail

GSC400 RS485 Input Connection

The GSC400 RS485 input connector is used for serial data communications. This connector may be used for software programming of the GSC400 using the GSC400 configurator software.

Terminal Detail	Terminal Location	Wire Size (AWG)	Current max.	Function
RS485-A	1	18	7mA	RS485 Connection
Ground	2	18	7mA	Ground Terminal Connection
RS485-B	3	18	7mA	RS485 Connection
RS485-A	4	18	7mA	RS485 Connection
Ground	5	18	7mA	Ground Terminal Connection
RS485-B	6	18	7mA	RS485 Connection

GSC400 Digital Output Connection

The GSC400 digital output connector is used to connect up to 8 outputs. Each output can be assigned 1 of the 34 possible selections.

Terminal Detail	Terminal Location	Wire Size (AWG)	Current max.	Function
+ Bat	1	18	1.5A	Positive Battery Voltage
Output A	2	18	200mA	Configurable*
Output B	3	18	200mA	Configurable*
Output C	4	18	200mA	Configurable*
Output D	5	18	200mA	Configurable*
Output E	6	18	200mA	Configurable*
Output F	7	18	200mA	Configurable*
Output G	8	18	200mA	Configurable*
Output H	9	18	200mA	Configurable*
+ Bat	10	18	1.5A	Positive Battery Voltage

*See Advanced Setup Menu Chart under Digital Output Setup for possible selections

GSC400 AC Voltage Sensing Connection

The GSC400 AC Voltage Sensing connector is used to measure the level of AC voltage being supplied to the system.

Terminal	Wire Size (AWG)	Current max.	Function
Phase A	18	7mA	Monitor Generated AC Voltage
Phase B	18	7mA	Monitor Generated AC Voltage
Phase C	18	7mA	Monitor Generated AC Voltage
Neutral	18	7mA	AC Voltage Neutral connection

GSC400 AC Current Sensing Connection

The GSC400 AC Current Sensing connector is used to measure the level of AC current being drawn from the load.

DANGER
HIGH
VOLTAGE

WARNING

DANGER
HIGH
VOLTAGE

It is extremely important to connect each phase to the appropriate terminal location. Never mix phase inputs. Always match terminal details to the matching terminal location.

Terminal Detail	Terminal Location	Wire Size (AWG)	Current max.	Function
Phase A	1	18	5A	Phase A current sensing CT+
Phase B	2	18	5A	Phase B current sensing CT+
Phase C	3	18	5A	Phase C current sensing CT+
Phase A	4	18	5A	Phase A current sensing CT-
Phase B	5	18	5A	Phase B current sensing CT-
Phase C	6	18	5A	Phase C current sensing CT-

GSC400 J1939 Canbus Connection

The GSC400 J1939 Canbus connector is used to communicate between J1939 complaint engines.

Terminal Detail	Terminal Location	Wire Size (AWG)	Current max.	Function
CANH	1	18	7mA	CANH Connection
Ground	2	18	7mA	Ground Terminal Connection
CANL	3	18	7mA	CANL Connection
Ground	4	18	7mA	Ground Terminal Connection

5:0 GSC400 Operation Modes:

The GSC400 incorporates 3 modes of operation:

1. OFF Mode
2. AUTO Mode
3. Manual Run Mode

1. OFF Mode – When the GSC400 is set to the Off Mode, starting will be disabled. No automatic controls will be initiated. The Off Mode may be initiated when no engine controls are required or when the menu system requires adjustment.



2. AUTO Mode - When the GSC400 is set to the Auto Mode, automatic starting will be enabled. Auto Mode allows for the automatic control of the engine. Possible causes of starting include start/stop, battery recharge and exerciser features. Failures will be automatically detected allowing for safe engine operation.



3. Manual Run Mode - When the GSC400 is set to the manual run Mode, starting will be enabled. Start Mode allows for immediate manual engine starting and operation. When in Start Mode, the engine will run until the OFF Mode is chosen or a failure is recognized. Controller must be in auto mode to initiate Manual run.



6:0 GSC400 Menu System:

The GSC400 utilizes an advanced yet user friendly menu system. The menu system can be initiated to perform adjustments within the GSC400. Adjustments can range from simple basic selections including time settings to more advanced selections including engine logic, input selection, output selection etc. Although the GSC400 is shipped factory configured either to its default or customer requested ranges, the internal menu system can be easily initiated for adjustments. With the controller in the off mode, the menu system may be selected simply by pressing the enter button.



Press “OFF” followed by “ENTER” to initiate GSC400 Menu System. Scroll using the ▲ and ▼ buttons on the GSC400. Enter selections by depressing the enter button



1

2



The backlight display will illuminate automatically upon button activation. The backlight will stay on for a period of 60 seconds.

6:1 GSC400 Controller Menu Overview:

The GSC400 Controller Features the Following Menu Functions:

1. Clock Setup
2. Basic Setup
3. Advanced Setup
4. Failure History



6:2 CLOCK SETUP:

FUNCTION	SELECTION AND RANGE
Back	Used to go back to previous menu
Year	2000 - 2099
Month	01-Jan to 12-Dec
Date	01-31
Day	Monday - Sunday
Hour	00-23
Minute	00-59
12/24	12/24 hour time display

- 1. Year:** User selectable allowing current year LCD display.
- 2. Month:** User selectable allowing current month LCD display.
- 3. Date:** User selectable allowing current date LCD display.
- 4. Day:** User selectable allowing current day LCD display.
- 5. Hour:** User selectable allowing current hour LCD display.
Hour must always be set in 24 hour time regardless of the 12/24 display setting.
- 6. Minute:** User selectable allowing current minute LCD display.
- 7. 12/24:** User selectable allowing current time LCD display.
Time may be displayed in 12/24 hour status.

6:3 BASIC SETUP:



FUNCTION	SELECTION AND RANGE
Contrast Adjust	5-95 %
Page Roll Delay	1-10 s
State Roll Delay	1-10 s

- 1. Contrast Adjust:** User selectable allowing different percent LCD contrast ratios.
- 2. Page Roll Delay:** User selectable allowing page roll delay times during run mode.
- 3. State Roll Delay:** User selectable allowing state roll delay times during run mode.



The contrast and delay settings will be automatically temperature compensated below 0° C. The compensated settings will allow the LCD display to be better viewable at lower temperatures. Please note that this is an automatic compensation and does not effect the actual contract adjust setting. If the controller is set for a 50% brightness level the display will stay at the level through a temperature change.

6:4 ADVANCED SETUP:

The GSC400 incorporates an advanced setup menu function. Advanced setup features include input, output and other advanced settings which are adjustable by the user if required. See the possible advanced setup menu selections on the following page.



A password is required to be correctly entered allowing access to the advanced menu selections. The password will consist of a four digit number. Each number needs to be selected using the up or down arrows on the GSC400. Simply choose the correct password number for each selected position by scrolling to the proper number followed by the enter button. The default company password will be 0 0 0 0. The password may be changed anytime. See Password Setup section.



The Advanced Setup menu on the GSC400.





Advanced Setup Menu

FUNCTION	SELECTION AND RANGE	
J1939 Setup	Manufacturer	Select J1939 ECU manufacturer
	Display Group 1	Enable, Disable
	Display Group 2	Enable, Disable
High Engine Temp	Input Pin	Reserve, Analog 2-7
	Signal Source	J1939, Switch input, Sender
	Bypass Delay	0-60 Seconds
	Switch Setting	GND = Fail, Open = Fail
	Shorted Sender	Disable, Warning, Shutdown
	Open Sender	Disable, Warning, Shutdown
	Units	Fahrenheit, Celius
	Warning Level	10-265°F, 10-265°C
	Failure Level	10-265°F, 10-265°C
Oil Pressure	Input Pin	Reserve, Analog 2-7
	Signal Source	J1939, Switch input, Sender
	Bypass Delay	0-60 Seconds
	Switch Setting	GND = Fail, Open = Fail
	Shorted Sender	Disable, Warning, Shutdown
	Open Sender	Disable, Warning, Shutdown
	Units	PSI, KPa
	Warning Level	0-90 PSI, 0-90 KPa
	Failure Level	0-90 PSI, 0-90 KPa
Fuel Level	Input Pin	Reserve, Analog 2-7
	Signal Source	J1939, Switch input, Sender
	Bypass Delay	0-60 Seconds
	Switch Setting	GND = Fail, Open = Fail
	Shorted Sender	Disable, Warning, Shutdown
	Open Sender	Disable, Warning, Shutdown
	Units	Percentage
	Warning Level	0-90%
	Failure Level	0-90%

Fuel Level (continued)	0% Fuel Level 25% Fuel Level 50% Fuel Level 100% Fuel Level	0-1000 Ohms (data sheet or measured value) 0-1000 Ohms (data sheet or measured value) 0-1000 Ohms (data sheet or measured value) 0-1000 Ohms (data sheet or measured value)
Oil Level	Input Pin Signal Source Bypass Delay Switch Setting Shorted Sender Open Sender Units Warning Level Failure Level	Reserve, Analog 2-7 J1939, Switch input, Sender 0-60 Seconds GND = Fail, Open = Fail Disable, Warning, Shutdown Disable, Warning, Shutdown Percentage 0-100% 0-100%
Fuel In Basin	Input Pin Signal Source Bypass Delay Switch Setting Shorted Sender Open Sender Units Warning Level Failure Level	Reserve, Analog 2-7 J1939, Switch input, Sender 10-60 Seconds GND = Fail, Open = Fail Disable, Warning, Shutdown Disable, Warning, Shutdown Percentage 0-90% 0-90%
Low Engine Temperature	Input Pin Signal Source Bypass Delay Switch Setting Shorted Sender Open Sender Units Warning Level Failure Level	Reserve, Analog 2-7 J1939, Switch input, Sender 10-60 Seconds GND = Fail, Open = Fail Disable, Warning, Shutdown Disable, Warning, Shutdown Fahrenheit, Celsius 10-265°F, 10-265°C 10-265°F, 10-265°C
Spd Sensing	Signal Source Rated Freq Rated RPM Over Speed Warn Over Speed Fail Under Speed Warn Under Speed Fail	J1939, Mag pickup, Gen output 10-9990 Hz 200-4000 RPM 100-5000 RPM 100-5000 RPM 100-5000 RPM 100-5000 RPM
AC Frequency	Frequency Disconnect Over Freq Warn Over Freq Fail Under Freq Warn Under Freq Fail	1-100 Hz 1-100 Hz 1-100 Hz 1-100 Hz 1-100 Hz
A/C Voltage	Voltage Source Voltage Display Voltage Group Over Volt Warn 1 Over Volt Fail 1 Under Volt Warn 1 Under Volt Fail 1 Over Volt Warn 2 Over Volt Fail 2	Disable, Wye Line-Line, Line-Neutral 1-Single, 2-Three, 3-Hi Wye, 4-Three phase 0-700 VAC 0-700 VAC 0-700 VAC 0-700 VAC 0-700 VAC 0-700 VAC

<p>A/C Voltage (continued)</p>	<p>Under Volt Warn 2 0-700 VAC Under Volt Fail 2 0-700 VAC Over Volt Warn 3 0-700 VAC Over Volt Fail 3 0-700 VAC Under Volt Warn 3 0-700 VAC Under Volt Fail 3 0-700 VAC Over Volt Warn 4 0-700 VAC Over Volt Fail 4 0-700 VAC Under Volt Warn 4 0-700 VAC Under Volt Fail 4 0-700 VAC</p>
<p>A/C Current</p>	<p>Current source Disable, Enable Turns Ratio 5-5000A:5A Over Current Warn 1 0-6500 A Over Current Fail 1 0-6500 A Over Current Warn 2 0-6500 A Over Current Fail 2 0-6500 A Over Current Warn 3 0-6500 A Over Current Fail 3 0-6500 A Over Current Warn 4 0-6500 A Over Current Fail 4 0-6500 A</p>
<p>Engine Logic</p>	<p>Delay to Start 0-60 seconds Pre-heat Time 0-60 seconds Crank Time 3-60 seconds MidHeat Time 0-60 seconds Crank Rest Time 1-60 seconds Crank Attempts 1-60 Fuel Crank Rest Disable, Enable False Restart Disable, Enable Post-Heat Time 0-60 seconds ETS On Duration 0-30 seconds Warm-up Time 0-600 seconds Crank Disconnect 100-2000 RPM Cool Down Delay 0-600 seconds Crank Oil pres 0-90 Psi</p>
<p>Digital Output Setup</p> <p>All selections apply to each individual output</p> <p>A specific selection may be mapped to more than one output to allow for higher current output.</p>	<p>Extra Relay Disable, Warm-Up, ETS, Output A Pre-heat, Cooldown, Output B Over Crank , High Temp Fail , Output C High Temp warn, Low Oil Fail , Output D Low Oil warn, Under Speed Fail, Output E Under Speed Warn, Over Speed Fail Output F Over Speed Warn, Low Fuel Fail Output G Low Fuel Warn, Battery Fail, Output H Battery Warn, Low Coolant Fail, Low Coolant warn, Not in Auto, Failure, Crank Rest, Engine Running, Crank On, Exerciser Alarm, Recharge Alarm Under Volt Warn, Over volt warn, Over Amp Warn, Fuel in Basin, Volt Regulator, Low Temp Warn. Back Light, Aux Warn.</p>

Exerciser setup	Exerciser Enable Run Duration Pre-Alarm Delay Repeat Frequency Start Hour Start Date	Disable, enable 10-240 minutes 1-20 minutes 1-672 hours 0-23 1-31
Digital Input Setup All selections apply to each individual input	Input A (Bat) Input B (Bat) Input C (Bat) Input D (Bat) Input E (Gnd) Input F (Gnd) Input G (Gnd) Input H (Gnd)	Disable, Low Air Pressure Low Hydraulic Pressure, EPS Supply Load Alarm Silence, Low Coolant, Volt Select 1, Volt Select 2, Idle Mode, Start/Stop Auxiliary Warn/Failure
Battery Setup	Low Auto Charge Charge Pre-Alarm Charge Duration Recharge Level Low Warn Level Low Fail Level High Warn Level High Fail Level	Disable, enable 1-60 minutes 10-240 minutes 7-24 volts 7-24 volts 7-24 volts 12-32 volts 12-32 volts
Set Password	Password No. 1 Password No. 2 Password No. 3 Password No. 4	0-9 0-9 0-9 0-9

6.4.1 J1939 Setup:

- a.) Manufacturer: Select engine manufacturer from list (John Deere/Volvo).
- b.) Display Group1: Enable/Disable extra display parameters displayed while running.
- c.) Display Group2: Enable/Disable extra display parameters displayed while running.

Engine Manufacturer	Display Group 1	Display Group 2
John Deere	Percent Engine Torque, Percent Friction Torque, Percent Load	Intake Temperature, Fuel Temperature, Fuel Rate
Volvo Penta	Percent Engine Torque, Percent Friction Torque, Percent Load	Boost Pressure, Oil Temperature, Fuel Rate

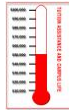

6.4.2 High Engine Temp:

This function allows the user to select the following settings:

- a.) **Input Pin:** Input 2-7 may be configured to High Engine Temp. A specific input can be assigned only once to any given function at any one time. If using a sender be careful to select a Low or High impedance input location to correspond to the sender specifications. Reserve may be selected to configure proper setting without assigning an active input.
- b.) **Signal Source:** How to obtain a high engine temperature failure.
The J1939 interface may be selected for a J1939 compliant engine. The switch input may be selected for a mechanical switch gauge types. Senders may be selected for electronic gauge types.
- c.) **Bypass Delay:** When to recognize an engine temperature failure. Bypass delay is the time in seconds the GSC400 will wait after crank success before checking engine for high engine temperature.
- d.) **Switch Setting:** When the Switch Input is selected as the signal source, the switch setting can be configured for a ground or open failure. Gnd means that ground would be a failure, +BAT would be “Engine OK”. Open means that open switch contacts would be “Failure”, and closed switch contacts would be a “Engine OK”.
- e.) **Shorted Sender:** When the Sender Input is selected as the signal source, a shorted sender can display a warning, shutdown the engine or be set to have no effect (disable).
- f.) **Open Sender:** When the Sender Input is selected as the signal source, an open sender can display a warning, shutdown the engine or be set to have no effect (disable).
- g.) **Units:** Fahrenheit or Celsius selectable.
- h.) **Warning Level:** Using an electronic sender or J1939 input, a value of 10-265° may be selected to initiating a warning.
Please note that if warning level is set to a greater value then failure level, no warning will be generated.
- i.) **Failure Level:** Using an electronic sender or J1939 input, a value of 10-265° may be selected to initiating a Failure.



6.4.3 Oil Pressure:

This function allows the user to select the following settings:

- a.) **Input Pin:** Input 2-7 may be configured to Oil Pressure. A specific input can be assigned only once to any given function at any one time. If using a sender be careful to select a Low or High impedance input location to correspond to the sender specifications. Reserve may be selected to configure proper setting without assigning an active input.
- b.) **Signal Source:** How to obtain an oil pressure failure.
The J1939 interface may be selected for a J1939 compliant engine. The switch input may be selected for a mechanical switch gauge types. Senders may be selected for electronic gauge types.
- c.) **Bypass Delay:** When to recognize an oil pressure failure. Bypass delay is the time in seconds the GSC400 will wait after crank success before checking engine Pressure.
- d.) **Switch Setting:** When the Switch Input is selected as the signal source, the switch setting can be configured for a ground or open failure. Gnd means that ground would be a failure, +BAT would be “Engine OK”. Open means that open switch contacts would be “Failure”, and closed switch contacts would be a “Engine OK”
- e.) **Shorted Sender:** When the Sender Input is selected as the signal source, a shorted sender can display a warning, shutdown the engine or be set to have no effect (disable).
- f.) **Open Sender:** When the Sender Input is selected as the signal source, an open sender can display a warning, shutdown the engine or be set to have no effect (disable).
- g.) **Units:** PSI or Kpa selectable.
- h.) **Warning Level:** Using an electronic sender or J1939 input, a value of 0-90 may be selected to initiating a warning.
Please note that if warning level is set to a greater value then failure level, no warning will be generated.
- i.) **Failure Level:** Using an electronic sender or J1939 input, a value of 0-90 may be selected to initiating a Failure.



6.4.4 Fuel Level:

This function allows the user to select the following settings:

- a.) Input Pin: Input 2-7 may be configured to Fuel Level. An input can only be assigned to any given function once at any given time. If using a sender be careful to select a Low or High impedance input location to correspond to the sender specifications. Reserve may be selected to configure proper setting without assigning an active input.
- b.) Signal Source: How to obtain an engine temperature failure.
The J1939 interface may be selected for a J1939 compliant engine. The switch input may be selected for a mechanical switch gauge types. Senders may be selected for electronic gauge types. Sender values for 0%, 25%, 50%, 75% and 100% are entered.
- c.) Bypass Delay: When to recognize a fuel level failure. Bypass delay is the time in seconds the GSC400 will wait after crank success before checking fuel level.
- d.) Switch Setting: When the Switch Input is selected as the signal source, the switch setting can be configured for a ground or open failure. Gnd means that ground would be a failure, +BAT would be “Engine OK”. Open means that open switch contacts would be “Failure”, and closed switch contacts would be a “Engine OK”
- e.) Shorted Sender: When the Sender Input is selected as the signal source, a shorted sender can display a warning, shutdown the engine or be set to have no effect (disable).
- f.) Open Sender: When the Sender Input is selected as the signal source, an open sender can display a warning, shutdown the engine or be set to have no effect (disable).
- g.) Units: Percentage.
- h.) Warning Level: Using an electronic sender or J1939 input, a value of 0-90% may be selected to initiating a warning.
Please note that if warning level is set to a greater value then failure level, no warning will be generated.
- i.) Failure Level: Using an electronic sender or J1939 input, a value of 0-90% may be selected to initiating a Failure.

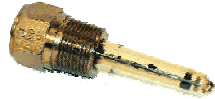

6.4.5 Oil Level:

This function allows the user to select the following settings:

- a.) **Input Pin:** Input 2-7 may be configured to Oil level. An input can only be assigned to any given function once at any given time. If using a sender be careful to select a Low or High impedance input location to correspond to the sender specifications. Reserve may be selected to configure proper setting without assigning an active input.
- b.) **Signal Source:** How to obtain an oil level failure.
The J1939 interface may be selected for a J1939 compliant engine. The switch input may be selected for a mechanical switch gauge types. Senders may be selected for electronic gauge types.
- c.) **Bypass Delay:** When to recognize an oil level failure. Bypass delay is the time in seconds the GSC400 will wait after crank success before checking oil level.
- d.) **Switch Setting:** When the Switch Input is selected as the signal source, the switch setting can be configured for a ground or open failure. Gnd means that ground would be a failure, +BAT would be “Engine OK”. Open means that open switch contacts would be “Failure”, and closed switch contacts would be a “Engine OK”
- e.) **Shorted Sender:** When the Sender Input is selected as the signal source, a shorted sender can display a warning, shutdown the engine or be set to have no effect (disable).
- f.) **Open Sender:** When the Sender Input is selected as the signal source, an open sender can display a warning, shutdown the engine or be set to have no effect (disable).
- g.) **Units:** Percentage.
- h.) **Warning Level:** Using an electronic sender, a value of 0-100% may be selected to initiating a warning.
Please note that if warning level is set to a greater value then failure level, no warning will be generated.
- i.) **Failure Level:** Using an electronic sender, a value of 0-100% may be selected to initiating a Failure.



6.4.6 Fuel in Basin:

This function allows the user to select the following settings:

- a.) **Input Pin:** Input 2-7 may be configured to Fuel in Basin. An input can only be assigned to any given function once at any given time. If using a sender be careful to select a Low or High input impedance location to correspond to the sender specifications. Reserve may be selected to configure proper setting without assigning an active input.
- b.) **Signal Source:** How to obtain a fuel in basin failure.
The J1939 interface may be selected for a J1939 compliant engine. The switch input may be selected for a mechanical switch gauge types. Senders may be selected for electronic gauge types.
- c.) **Bypass Delay:** When to recognize a fuel in basin failure. Bypass delay is the time in seconds the GSC400 will wait after crank success before checking for a fuel in basin failure.
- d.) **Switch Setting:** When the Switch Input is selected as the signal source, the switch setting can be configured for a ground or open failure. Gnd means that ground would be a failure, +BAT would be “Engine OK”. Open means that open switch contacts would be “Failure”, and closed switch contacts would be a “Engine OK”
- e.) **Shorted Sender:** When the Sender Input is selected as the signal source, a shorted sender can display a warning, shutdown the engine or be set to have no effect (disable).
- f.) **Open Sender:** When the Sender Input is selected as the signal source, an open sender can display a warning, shutdown the engine or be set to have no effect (disable).
- g.) **Warning Level:** Using an electronic sender, a value of 0-90% may be selected to initiating a warning.
Please note that if warning level is set to a greater value then failure level, no warning will be generated.
- h.) **Failure Level:** Using an electronic sender, a value of 0-90% may be selected to initiating a Failure.



6.4.7 Low Engine Temp:

This function allows the user to select the following settings:

- a.) **Input Pin:** Input 2-7 may be configured to Low Engine Temp. An input can only be assigned to any given function once at any given time. If using a sender be careful to select a Low or High impedance input location to correspond to the sender specifications. Reserve may be selected to configure proper setting without assigning an active input.
- b.) **Signal Source:** How to obtain a low engine temperature failure.
The J1939 interface may be selected for a J1939 compliant engine. The switch input may be selected for a mechanical switch gauge types. Senders may be selected for electronic gauge types.
- c.) **Bypass Delay:** When to recognize a low engine temperature failure. Bypass delay is the time in seconds the GSC400 will wait after crank success before checking engine temperature.
- d.) **Switch Setting:** When the Switch Input is selected as the signal source, the switch setting can be configured for a ground or open failure. Gnd means that ground would be a failure, +BAT would be “Engine OK”. Open means that open switch contacts would be “Failure”, and closed switch contacts would be a “Engine OK”.
- e.) **Shorted Sender:** When the Sender Input is selected as the signal source, a shorted sender can display a warning, shutdown the engine or be set to have no effect (disable).
- f.) **Open Sender:** When the Sender Input is selected as the signal source, an open sender can display a warning, shutdown the engine or be set to have no effect (disable).
- g.) **Units:** Fahrenheit or Celsius selectable.
- h.) **Warning Level:** Using an electronic sender or J1939 input, a value of 10-265° may be selected to initiating a warning.
Please note that if warning level is set to a greater value then failure level, no warning will be generated.
- i.) **Failure Level:** Using an electronic sender or J1939 input, a value of 10-265° may be selected to initiating a Failure.



6.4.5 Speed Sensing:

This function allows the user to select the following settings:

- a.) **Signal Source:** How to obtain engine speed. The J1939 interface may be selected for a J1939 compliant engine. The magnetic pickup option may be selected for speed sensing from the engine flywheel. Generator output option may be selected for speed sensing directly from the generator output.
- b.) **Rated Freq:** Normal running frequency of the engine. Used to calculate engine speed. Select rated frequency between 10-9990 Hz
- c.) **Rated Speed:** Normal running speed of the engine. Used to calculate engine speed. Select rated speed between 200-4000 RPM
- d.) **Over Speed Warning:** This warning value is the value in RPM which the controller will recognize if the RPM level exceeds the setting and indicate a warning condition. A value of between 100-5000 RPM may be selected. * Please note that if warning level is set to a greater value then failure level, no warning will be generated.
- e.) **Over Speed Failure:** When the engine is running the RPM level is measured, the GSC400 can be configured for a choosing failure value. The Failure value is the value in RPM which the controller will recognize a failure. A value of between 100-5000 RPM may be selected.
- f.) **Under Speed Warning:** This warning value is the value in RPM which the controller will recognize if the RPM level goes beneath the setting and indicate a warning condition. A value of between 100-5000 RPM may be selected. * Please note that if warning level is set to a less value then failure level, no warning will be generated.
- g.) **Under Speed Failure:** When the engine is running the RPM level is measured, the GSC400 can be configured for choosing a failure value. The Failure value is the value in RPM which the controller will recognize a failure. A value of between 100-5000 RPM may be selected.

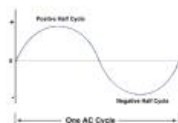

6.4.6 A/C Voltage:

This function allows the user to select the following settings:

- a.) **Voltage Source:** How to recognize the AC power source. The disable option may be selected if no AC power source is being monitored.
- b.) **Voltage Display:** Select to display type line-line or line-neutral. Voltage measured in line-neutral only, line-line uses calculated value.
- c.) **Voltage Group:** Select the AC power type being used 1-Single, 2-Three, 3-Hi Wye or 4-Three Phase. The group selected will determine what type of set points to use. Please note when digital input volt select is used for sensing, the voltage group selection will be overwritten.
- d.) **Over Voltage Warning**
1, 2, 3 or 4: When the AC voltage level is monitored, warning 1, 2, 3 or 4 may be selected depending upon the voltage group. This warning value is the level in which the controller will recognize if the generated voltage exceeds the setting and indicate a warning. * Please note that if warning level is set to a greater value then failure level, no warning will be generated.
- e.) **Over Voltage Failure**
1, 2, 3 or 4: When the AC voltage level is monitored, failure 1, 2, 3 or 4 may be selected depending upon the voltage group. The Failure value is the value in which the controller will recognize if the generated voltage exceeds the setting and will recognize a failure.
- f.) **Under Voltage Warning**
1, 2, 3 or 4: When the AC voltage level is monitored, warning 1, 2, 3 or 4 may be selected depending upon the voltage group. This warning value is the level in which the controller will recognize if the generated voltage falls beneath the setting indicate a warning. Settings apply only to the specific voltage group selected. * Please note that if warning level is set to a greater value then failure level, no warning will be generated.
- g.) **Under Voltage Failure**
1, 2, 3 or 4: When the AC voltage level is monitored, failure 1, 2, 3 or 4 may be selected depending upon the voltage group. Failure value is the value in which the controller will recognize if the generated voltage falls beneath the setting and will recognize a failure.

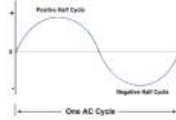

6.4.7 A/C Current:

This function allows the user to select the following settings:

- a.) **Current Source:** Allows monitoring of the current draw on the generator.
The enable option may be selected for monitoring the amount of current being draw from the engine. The disable option may be selected if no current monitoring is required.
- b.) **Turns Ratio:** The turns ratio is user adjustable and must match the current CT being used. The correct value may be seen on the current CT and must enter the value in the correct format as XA:5A where X is the setting enter from the CT.
- c.) **Over Current Warning**
1, 2, 3 or 4: When the AC current level is monitored, Warning 1, 2, 3 or 4 may be selected depending upon the voltage group.
This warning value is the level in which the controller will recognize if the generated current load exceeds the setting and indicate a warning. A value of between 0-6500A may be selected. Settings apply only to the specific voltage group selected.
* Please note that if warning level is set to a greater value then failure level, no warning will be generated.
- d.) **Over Current Failure**
1, 2, 3 or 4: When the AC current level is monitored, Failure 1, 2, 3 or 4 may be selected depending upon the voltage group.
This Failure value is the value in which the controller will recognize if the current draw exceeds the setting and will recognize a failure. A value of between 0-6500A may be selected. Settings apply only to the specific voltage group selected.



6.4.8 Engine Logic:

This function allows the user to select the following settings:

- a.) Delay to Start: This is the time in seconds that the GSC400 will wait before starting the generator. User adjustable 0-60 s.
- b.) Pre-heat Time: This is the time in seconds that the GSC400 will preheat the engine. Preheat occurs before the engine cranking cycle. User adjustable 0-60 s.
- c.) Crank Time: This is the time in seconds the GSC400 will continue to crank the generator. The controller will engage the flywheel until engine start or the crank time expires. User adjustable 3-60 s. If no speed after 2s of crank time, controller looks for locked rotor condition.
- d.) MidHeat Time: This is the time in seconds that the GSC400 will preheat the engine. Midheat occurs during the engine cranking cycle. User adjustable 0-60 s.
- e.) Rest Time: This is the time in seconds the GSC400 will wait between crank attempts. If engine starting is unsuccessful after the specific crank time, the starter will disengage for a specific time period. User adjustable 1-60 s.
- f.) Crank Attempt: This is the number of crank attempts the GSC400 will perform before going into over crank failure. User adjustable 1-60 s.
- g.) Fuel Crank Rest: This enables an energized fuel output while the controller is in rest time.
- h.) False Restart: With this option enabled, when the engine stalls within 10 seconds of crank disconnect, the GSC400 will re-attempt to start the generator. User adjustable enable or disable.
- i.) Post-Heat Time: This is the time in seconds that the GSC400 will post-heat the engine. Post-heat occurs during the initial stage of engine run. User adjustable 0-60 s.
- j.) Warm-up Time: This is the time in seconds in order to allow the generator sufficient time to warm up. This option must be enable in order to be used. User adjustable 0-600 s.

- k.) ETS on Duration: Energize to stop. Amount of time ETS is enabled during engine shutdown. User adjustable 0-30 s.
- l.) Cooldown: Delay: This is the time in seconds the GSC400 will wait before shutting the generator down under a no load condition in order to allow engine cool down. User adjustable 0-600 s.:
- m.) RPM Disconnect: This is the frequency at which the GSC400 will disengage the crank, keeping the fuel on to run the generator. User adjustable 100-2000 RPM.
- n.) Crank Oil Pressure: This is the oil pressure which is exceeded during cranking. Used for locked rotor detection as a means of detecting if the engine is cranking in the event of a faulty speed signal.

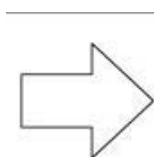

6.4.9 Digital Output Setup:

This function allows the user to select the following settings:

The GSC400 has 8 outputs plus an additional extra relay available for assignment. Each of the available outputs may be assigned only one output function at any given time.

Outputs may be assigned to the following functions.

- | | |
|----------------------|------------------------|
| 1. Warm-Up | 18. Low Coolant warn |
| 2. ETS | 19. Low Coolant fail |
| 3. Pre-heat | 20. Not in Auto |
| 4. Cooldown | 21. Failure |
| 5. Over Crank | 22. Crank Rest |
| 6. High Temp Warn | 23. Engine Running |
| 7. High Temp Fail | 24. Crank On |
| 8. Low Oil warn | 25. Exerciser Alarm |
| 9. Low Oil fail | 26. Recharge Alarm |
| 10. Under Speed warn | 27. Under Voltage warn |
| 11. Under Speed fail | 28. Under Voltage fail |
| 12. Over Speed warn | 29. Over Amp warn |
| 13. Over Speed fail | 30. Fuel in Basin |
| 14. Low Fuel warn | 31. Voltage Regulator |
| 15. Low Fuel fail | 32. Low Temp warn |
| 16. Battery warn | 33. Back Light |
| 17. Battery fail | 34. Aux Warn |



6.4.10 Exerciser Setup:

This function allows the user to select the following settings:

- a.) **Exerciser Enable:** The exerciser is user selectable as enabled or disabled. The exerciser enable only applies when in Auto mode and allows for the automatic starting and stopping of the engine.
- b.) **Run Duration:** The exerciser will automatically run the engine for a specified duration. The run duration is user selectable from 10-240 minutes.
- c.) **Pre-alarm Delay:** This is the delay time that the GSC400 will sound an audible alert before the exerciser starts the engine. The higher the delay setting the longer warning will be sounded to anyone who may be around the engine.
- d.) **Repeat Interval:** The exerciser is capable of automatically starting and stopping the engine at a set interval. The user may select the repeat interval according to the start hour and date. The selectable range is between 0-672 hours.
- e.) **Start Hour:** The exerciser will automatically start the engine depending upon the start hour setting
- f.) **Start Date:** The exerciser will automatically start the engine depending upon the start date setting

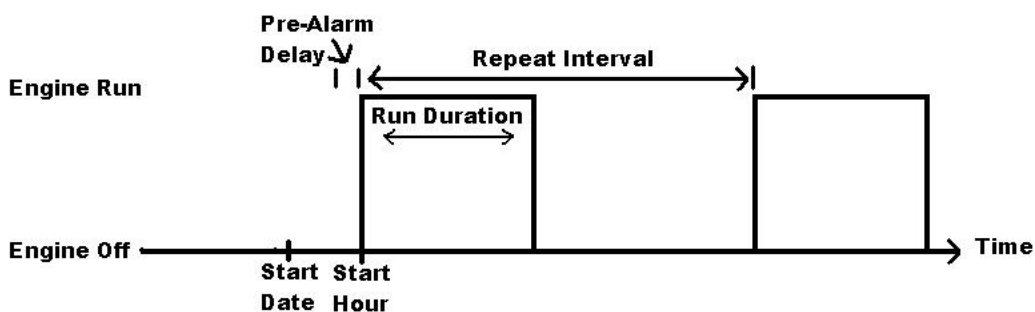



6.4.11 Digital Input Setup:

This function allows the user to select the following settings:

The GSC400 has 8 inputs available for assignment.

Each of the available inputs may be assigned only one input function at any given time.

Inputs A-D are switch to Bat inputs to activate.

Inputs E-H are switch to Gnd inputs to activate.

Inputs may be assigned to the following functions.

- | | |
|---------------------------|--------------------|
| 1. Low Air Pressure | 7. Volt Select 2 |
| 2. Low Hydraulic Pressure | 8. Idle Mode |
| 3. EPS Supply Load | 9. Start/Stop |
| 4. Alarm Silence | 10. Auxiliary Warn |
| 5. Low Coolant | 11. Auxiliary Fail |
| 6. Voltage Select 1 | |



6.4.12 Battery Setup:

This function allows the user to select the following settings:

- a.) Low Auto Charge: Low auto charge allows for the automatic starting of the engine in low battery conditions. The engine will run to charge the battery. User selectable as disabled or enabled.
- b.) Charge Pre-Alarm: Charge pre-alarm allows for the automatic warning of the engine starting in low battery conditions. The alarm will sound to warn of a low battery condition and that the engine will be starting. User selectable from 1-60 seconds.
- c.) Charge Duration: Charge duration is the number of minutes the engine will run to charge a low battery. User selectable from 10-240 minutes.
- d.) Recharge Level: The level which a low battery will be charged to when requiring charging, not exceeding the charge duration. User selectable from 7-24 volts.
- e.) Low Failure Level: The battery level detected as a low voltage requiring engine start. User selectable from 7-24 volts.
- f.) Low Warning Level: The battery level detected as a low voltage to sound warning. User selectable from 7-24 volts.
- g.) High Failure Level: The battery level detected as a high voltage requiring engine shutdown. User selectable from 12-32 volts.
- h.) High Warning Level: The battery level detected as a high voltage to sound warning. User selectable from 12-32 volts.

* All battery setup settings are available only in auto mode.

6.4.13 Password Setup:



The GSC400 allows a password be entered to protect any modifications from being made to adjustments within the advanced setup menu. A four digit password may be selected. This password will be needed to perform any changes to the advanced setup.

If the password is entered incorrectly, three chances will be allowed before the GSC400 returns back to the main menu.



To set password:

- Select Password No.1
Enter the desired number 0-9
- Select Password No.2
Enter the desired number 0-9
- Select Password No.3
Enter the desired number 0-9
- Select Password No.4
Enter the desired number 0-9

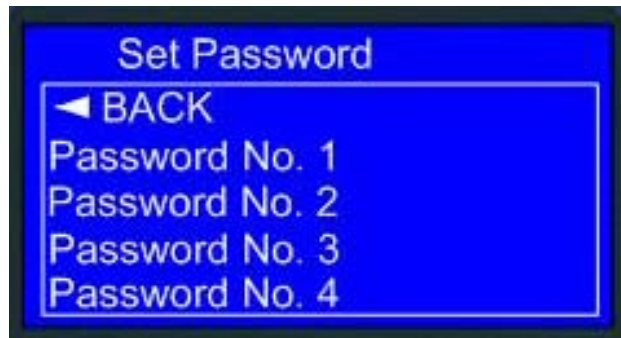

Remember to write down the password for future reference.

Default password = 0 0 0 0

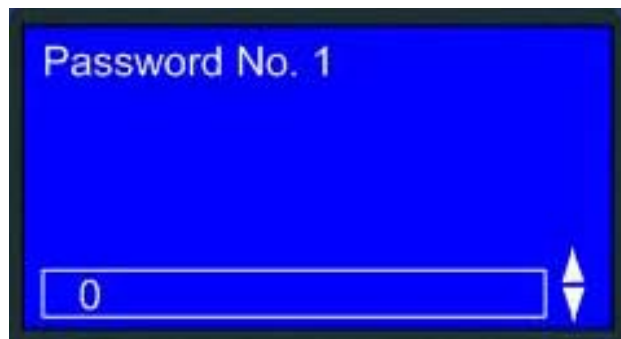



6:5 FAILURE HISTORY:

The GSC400 incorporates an advanced failure status history logging system. When engine failures occur, the failure condition information is documented into the GSC400 failure history log. The failure log may be displayed by entering the GSC400 menu system as explained in section 4: GSC400 Menu System.



A total of the last 99 failure conditions will be recorded within the log. Failure conditions may be viewed simply by scrolling up or down throughout the menu. In addition to the failure condition information, the associated date and time of the failure will be displayed.



Simply scroll through the failure history log by depressing the  or  Buttons located on the GSC400.



6.6 Default GSC400 Settings:

GSC400's are factory programmed and shipped with Default settings.
Customized settings may be factory programmed upon request.

FUNCTION	DEFAULT SETTINGS	
J1939	Manufacturer	John Deere
	Display Group 1	Disable
	Display Group 2	Disable
High Engine Temp	Input Pin	Input Pin 2
	Signal Source	Sender #1
	Bypass Delay	30 Seconds
	Switch Setting	GND = Fail
	Shorted Sender	Disable
	Open Sender	Disable
	Units	Fahrenheit
	Warning Level	200°F
	Failure Level	220°F
Oil Pressure	Input Pin	Input Pin 3
	Signal Source	Sender #1
	Bypass Delay	30 Seconds
	Switch Setting	GND = Fail
	Shorted Sender	Disable
	Open Sender	Disable
	Units	PSI
	Warning Level	20 PSI
	Failure Level	15 PSI
Fuel Level	Input Pin	Input Pin 4
	Signal Source	Sender
	Bypass Delay	30 Seconds
	Switch Setting	GND = Fail
	Shorted Sender	Disable
	Open Sender	Disable
	Units	Percentage
	Warning Level	25%
	Failure Level	5%
Oil Level	Input Pin	Input Pin 5
	Signal Source	Switch
	Bypass Delay	10 Seconds
	Switch Setting	GND = Fail
	Shorted Sender	Disable
	Open Sender	Disable
	Units	Percentage
	Warning Level	10%
	Failure Level	5%
Fuel In Basin	Input Pin	Input Pin 6
	Signal Source	Switch
	Bypass Delay	11 Seconds
	Switch Setting	GND = Fail
	Shorted Sender	Disable
	Open Sender	Disable
	Units	Percentage
	Warning Level	2%
	Failure Level	5%



Engine Logic	Delay to Start Pre-heat Time Crank Time MidHeat Time Crank Rest Time Crank Attempts Fuel Crank Rest False Restart Post-Heat Time ETS On Duration Warm-up Time Crank Disconnect Cool Down Delay Crank Oil pres	0 seconds 10 seconds 15 seconds 0 seconds 15 seconds 3 Disable Disable 0 seconds 0 seconds 0 seconds 650 RPM 0 seconds 10 PSI
Digital Output Setup All selections apply to each individual output	Extra Relay Output 1 Output 2 Output 3 Output 4 Output 5 Output 6 Output 7 Output 8	Disable, Low Fuel Failure High Temperature Failure Over Crank Failure Over Speed Failure Common Failure Not in Auto Engine Running Battery Warning
Exerciser setup	Exerciser Enable Run Duration Pre-Alarm Delay Repeat Frequency Start Hour Start Date	Disable 30 minutes 5 minutes 336 hours (14 days) 12 8
Digital Input Setup All selections apply to each individual input	Input 1 (Bat) Input 2 (Bat) Input 3 (Bat) Input 4 (Bat) Input 5 (Gnd) Input 6 (Gnd) Input 7 (Gnd) Input 8 (Gnd)	Low Air Pressure Low Hydraulic Pressure, EPS Supply Load Alarm Silence Low Coolant Level Voltage Select 1 Voltage Select 2 Idle Mode
Battery Setup	Low Auto Charge Charge Pre-Alarm Charge Duration Recharge Level Low Warn Level Low Fail Level High Warn Level High Fail Level	Disable 1 minute 10 minutes 10.4 volts 11.2 volts 9 volts 15 volts 16 volts
Set Password	Password No. 1 Password No. 2 Password No. 3 Password No. 4	0 0 0 0

7:0 GSC400 LED STATUS INDICATOR

The GSC400 incorporates an advanced failure status system. In addition to displaying messages and failure status indications on the controllers LCD display, the uses of LED indicators are included within the GSC400. Specific LED indicators will be illuminated depending upon the condition of the controller. The benefit of the GSC400 LED indicators allows a quick visual representation of the controller’s condition.



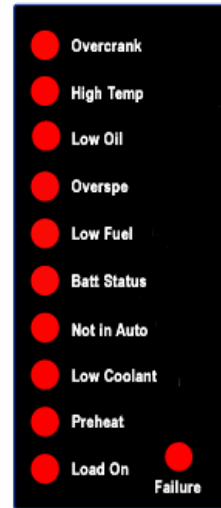

The GSC400 displays multi color LED’s for specific condition representation.

-  Red
- Represents Failure Conditions
-  Green
- Represents Active Conditions
-  Yellow
- Represents Warning Conditions















LED section of the GSC400









An LED test may be performed by the user for illumination of all controller LED’s. The LED test may be performed by simultaneously pressing the UP button  and the DOWN button  on the GSC400.

7:1 GSC400 LED Indication Chart:

The following chart represents a visual representation of status LED located on the GSC400.

LED DESCRIPTION	LED COLOR	LED STATUS	Indication
Over Crank	 Red	Solid Red	A solid red illuminated LED represents an Over Crank Failure condition.
	 Yellow	Solid Yellow	A solid yellow illuminated LED represents an Over Crank Warning condition.
High Temp	 Red	Solid Red	A solid red illuminated LED represents a High Temp Failure condition.
	 Yellow	Solid Yellow	A solid yellow illuminated LED represents a High Temp Warning condition.
Low Oil	 Red	Solid Red	A solid red illuminated LED represents a Low Oil Failure condition.
	 Yellow	Solid Yellow	A solid yellow illuminated LED represents a Low Oil Warning condition.
Over Speed	 Red	Solid Red	A solid red illuminated LED represents an OverSpeed Failure condition.
	 Yellow	Solid Yellow	A solid yellow illuminated LED represents an OverSpeed Warning condition.
Low fuel	 Red	Solid Red	A solid red illuminated LED represents a Low Fuel Failure condition.
	 Yellow	Solid Yellow	A solid yellow illuminated LED represents a Low Fuel Warning condition.
Battery Status	 Green	Solid Green	A solid green illuminated LED represents an accurate battery condition.
		Flashing Green	Controller in Auto mode – Waiting to start
	 Yellow	Solid Yellow	A solid yellow illuminated LED represents a Low Battery condition.

LED DESCRIPTION	LED COLOR	LED STATUS	Indication
Not In Auto	 Red	Solid Red	A solid red illuminated LED represents a Not in Auto condition.
Low Coolant	  Yellow	Solid Red Solid Yellow	A solid red illuminated LED represents a Low Coolant failure condition. A solid yellow illuminated LED represents a Low Coolant Warning condition.
Pre-Heat	 Green	Solid Green	A solid green illuminated LED represents an active Pre-Heat condition.
EPS Supplying Load	 Green	Solid Green	A solid red illuminated LED represents an active load condition.
Failure	 Red	Solid Red	A solid red illuminated LED represents a general Failure condition.

8:0 RECOMMENDED MAINTENANCE



WARNING: When performing any GSC400 or Engine maintenance be certain controller in OFF Mode, isolated from all possible sources of power, and Crank wire is removed from the Controller.



Periodically inspect all fasteners, terminals, connections and wiring for any loose or damaged parts.

Periodically inspect and remove any debris/dirt from within or near the controller.

Periodically inspect the operating area of the GSC400 for a safe and accurate mounting environment.

Procedure	Action
Making the controller safe for inspection and maintenance.	Disconnect all possible power sources before controller inspection.
Inspect controller mounting location for possible safety issues	Inspect mounting location for any safety or fire issues. Inspect for dirt, wiring damage and mechanical damages.
Inspect controller for loose fasteners, terminals and wiring connections.	Check all hardware including controller wiring, terminals etc. for any looseness due to vibrations etc.
Check for any overheating due to loose connections	Check for any discoloration, melting or blistering of any wiring or connections
Perform regular testing of controller	Perform regular testing of the controller to check for proper operation.